

1283/15-TR

PORTALAMPADE A COLONNA PER LAMPADE FLUORESCENTI LINEARI T5 TOMBSTONE LAMPHOLDER FOR T5 FLUORESCENT LINEAR LAMPS

Dati tecnici

Technical data







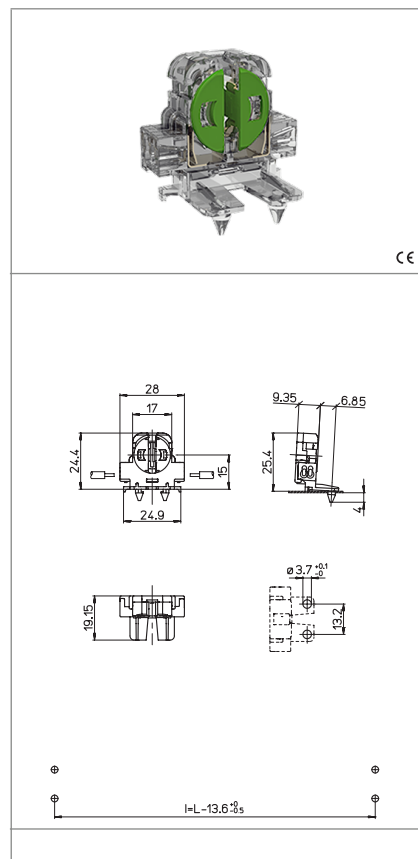

- Attacco lampada - Lamp Cap	G5
- Corrente e tensione nominale - Rated current and voltage	2A-500V
- Temperatura massima di funzionamento (IEC) - Maximum operating temperature (IEC)	T130 Tm110
- Grado di protezione - Protection index	IP20
- Categoria di sovratensione - Impulse withstand category	II

Caratteristiche

Characteristics

- Corpo in policarbonato trasparente
- Transparent polycarbonate body
- Contatti in lega di rame
- Copper alloy contacts



 fissaggio ad innesto push-in fixing	 spessore lamiera di fissaggio fixing metal plate thickness 0,6-1	 altezza centro lampada (da sopra la lamiera) lamp centre height (from the top of the metal plate) 15	 rotore in PBT verde con scatti di... PBT green rotor with position of...
 serrafilo automatico a 2 fori push-wire terminals with 2 holes	 sezione conduttori rigidi rigid conductor section 0,5-1	 spelatura cavetti rigidi rigid wires stripping 8-9	 IP40 nei punti d'aggancio IP40 in the hooking points

Marchi di qualità

Quality marks

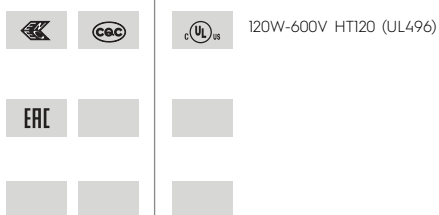

Direttive Europee

European directives

Conforme "RoHS"
"RoHS" compliant
Non soggetto alla "RAEE"
Not subject to "WEEE"

Pesi e confezioni

Weights and packaging

Art. Codice prodotti Product references	g Peso netto Net weight	n° pz per sacco per bag	n° pz per scatola per box	n° pz per cartone per carton
1283/15-TR	4	1000		

Note

Notes