

1911/TR

1911/SN-TR

PORTALAMPADE PROTETTI PER LAMPADINE FLUORESCENTI LINEARI T5 + TUBO DI PROTEZIONE PROTECTED LAMP HOLDERS FOR T5 LINEAR FLUORESCENT LAMPS + COVER TUBE

Dati tecnici

Technical data







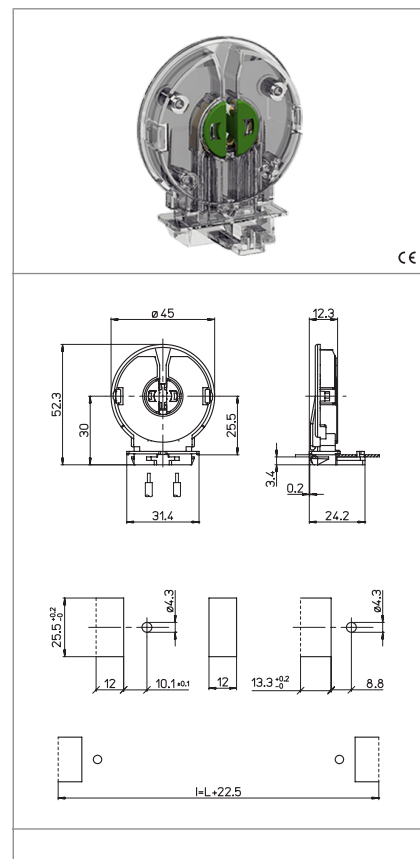

- Attacco lampada - Lamp Cap	G5
- Corrente e tensione nominale - Rated current and voltage	2A-500V
- Temperatura massima di funzionamento (IEC) - Maximum operating temperature (IEC)	T130 Tm110
- Grado di protezione - Protection index	IP40 con/with: S-1911/...
- Categoria di sovratensione - Impulse withstand category	II

Caratteristiche

Characteristics

- Corpo in policarbonato trasparente
- Transparent polycarbonate body
- Contatti in lega di rame
- Copper alloy contacts



 fissaggio ad innesto snap-in fixing	 spessore lamiera di fissaggio fixing metal plate thickness 0,6-1,2	 altezza centro lampada (da sopra la lamiera) lamp centre height (from the top of the metal plate) 25,5	 versione senza nasello versione senza stop nib
 rotore in PBT verde con scatti di... PBT green rotor with position of... 90°	 serrafilo automatico a 2 fori push-wire terminals with 2 holes	 sezione conduttori rigidi rigid conductor section mm ² 0,5-1	 spelatura cavetti rigidi rigid wires stripping 8-9
 IP40 con S-1911/... IP40 with S-1911/...			

Marchi di qualità

Quality marks

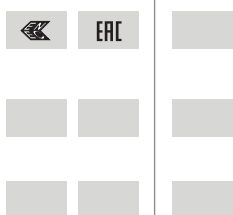

Direttive Europee

European directives

Conforme "RoHS"
"RoHS" compliant
Non soggetto alla "RAEE"
Not subject to "WEEE"

Pesi e confezioni

Weights and packaging

Art. Codice prodotti Product references	g Peso netto Net weight	n° pz per sacco per bag	n° pz per scatola per box	n° pz per cartone per carton
1911/TR				
1911/SN-TR				

Note

Notes