

1911/T-TR

1911/T-SN-TR

PORTALAMPADE PROTETTI PER LAMPADINE FLUORESCENTI LINEARI T5 + TUBO DI PROTEZIONE
PROTECTED LAMP HOLDERS FOR T5 LINEAR FLUORESCENT LAMPS + COVER TUBE

Dati tecnici

Technical data









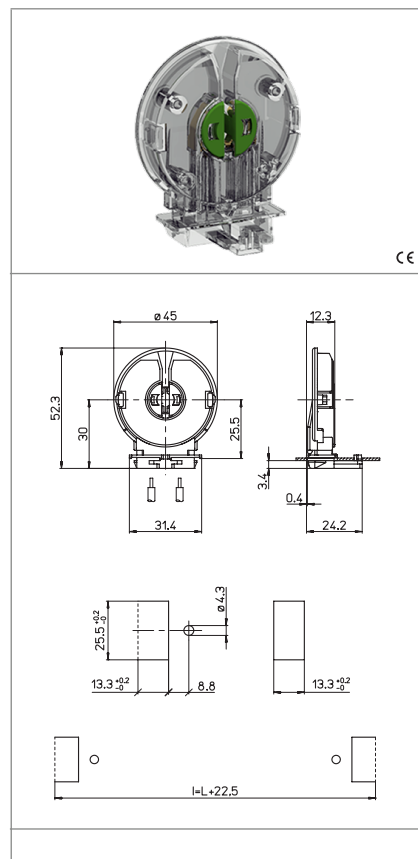

- Attacco lampada - Lamp Cap	G5
- Corrente e tensione nominale - Rated current and voltage	2A-500V
- Temperatura massima di funzionamento (IEC) - Maximum operating temperature (IEC)	T130 Tm110
- Grado di protezione - Protection index	IP40 con/with: S-1911/...
- Categoria di sovratensione - Impulse withstand category	II

Caratteristiche

Characteristics

- Corpo in policarbonato trasparente
- Transparent polycarbonate body
- Contatti in lega di rame
- Copper alloy contacts



 fissaggio ad innesto <i>snap-in fixing</i>	 spessore lamiera di fissaggio <i>fixing metal plate thickness</i> 0,6-1,2	 altezza centro lampada (da sopra la lamiera) <i>lamp centre height (from the top of the metal plate)</i> 25,5	 adatto per fissaggio solo in cave da 13,3x25,5 mm <i>suitable only for fixing into 13,3x25,5 mm holes</i>
 versione senza nasello <i>version without stop nib</i>	 rotore in PBT verde con scatti di... <i>PBT green rotor with position of...</i> 90°	 serrafilo automatico a 2 fori <i>push-wire terminals with 2 holes</i>	 sezione conduttori rigidi <i>rigid conductor section</i> 0,5-1 mm ²
 spelatura cavetti rigidi <i>rigid wires stripping</i> 8-9	 IP40 con S-1911/... <i>IP40 with S-1911/...</i>		

Marchi di qualità

Quality marks

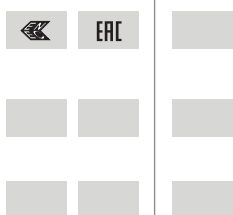

Direttive Europee

European directives

Conforme "RoHS"
"RoHS" compliant
Non soggetto alla "RAEE"
Not subject to "WEEE"

Pesi e confezioni

Weights and packaging

Art. Codice prodotti <i>Product references</i>	g Peso netto <i>Net weight</i>	n° pz per sacco <i>per bag</i>	n° pz per scatola <i>per box</i>	n° pz per cartone <i>per carton</i>
1911/T-TR	9,8		100	
1911/T-SN-TR				

Note

Notes