

## 1912-10/TR

## 1912-10/SN-TR

### PORTALAMPADE PROTETTI PER LAMPADE FLUORESCENTI LINEARI T5 + TUBO DI PROTEZIONE PROTECTED LAMPHOLDERS FOR T5 LINEAR FLUORESCENT LAMPS + COVER TUBE

#### Dati tecnici

##### Technical data







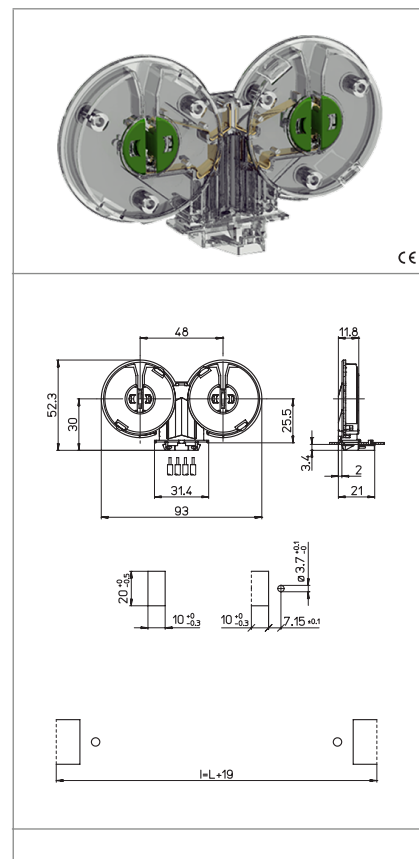

- Attacco lampada - Lamp Cap	G5
- Corrente e tensione nominale - Rated current and voltage	2A-500V
- Temperatura massima di funzionamento (IEC) - Maximum operating temperature (IEC)	T130 Tm110
- Grado di protezione - Protection index	IP40 con/with: S-1911/...
- Categoria di sovratensione - Impulse withstand category	II

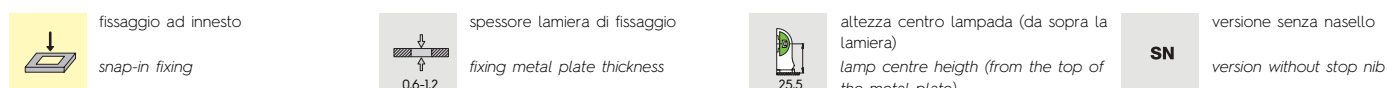
#### Caratteristiche

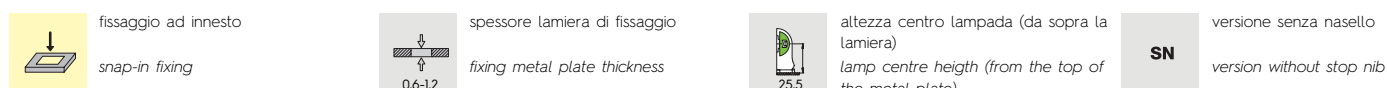
##### Characteristics

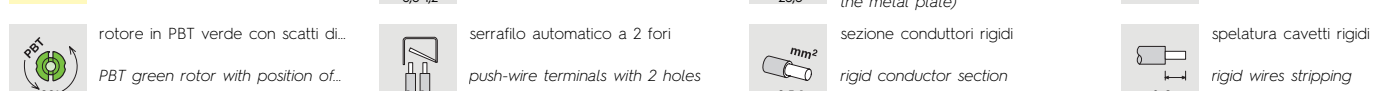
- Corpo in policarbonato trasparente  
- Transparent polycarbonate body
- Contatti in lega di rame  
- Copper alloy contacts

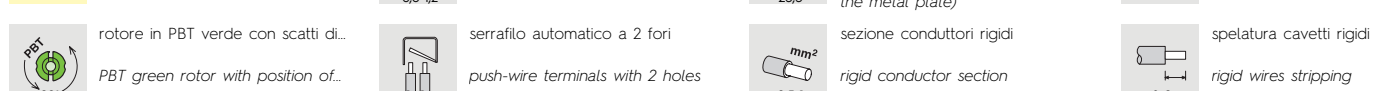

 fissaggio ad innesto snap-in fixing	 spessore lamiera di fissaggio fixing metal plate thickness 0,6-1,2	 altezza centro lampada (da sopra la lamiera) lamp centre height (from the top of the metal plate) 25,5	 versione senza nasello version without stop nib SN
 rotore in PBT verde con scatti di... PBT green rotor with position of... 90°	 serrafilo automatico a 2 fori push-wire terminals with 2 holes	 sezione conduttori rigidi rigid conductor section mm <sup>2</sup> 0,5-1	 spelatura cavetti rigidi rigid wires stripping 8-9
 IP40 con S-1911/... IP40 with S-1911/...			

#### Marchi di qualità

##### Quality marks

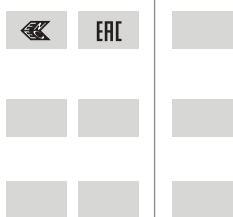

#### Direttive Europee

##### European directives

Conforme "RoHS"  
"RoHS" compliant  
Non soggetto alla "RAEE"  
Not subject to "WEEE"

#### Pesi e confezioni

##### Weights and packaging

Art. Codice prodotti Product references	g Peso netto Net weight	n° pz per sacco per bag	n° pz per scatola per box	n° pz per cartone per carton
1912-10/TR	17,1		100	
1912-10/SN-TR				

#### Note

##### Notes