

1880-G5/16-TR

PORTALAMPADE PROTETTO PER LAMPADE FLUORESCENTI LINEARI T5 PROTECTED LAMPHOLDER FOR T5 LINEAR FLUORESCENT LAMPS

Dati tecnici

Technical data









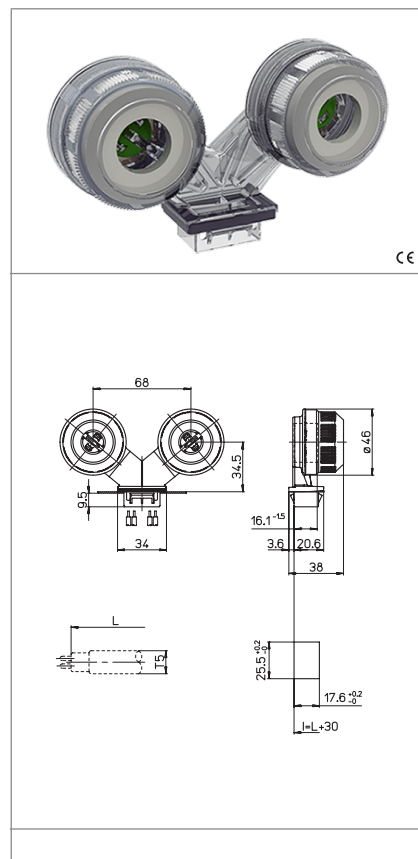



| | |
|---|---------------|
| - Attacco lampada - Lamp Cap | G5 |
| - Corrente e tensione nominale - Rated current and voltage | 2A-500V |
| - Temperatura massima di funzionamento (IEC) - Maximum operating temperature (IEC) | T140 Tm110 |
| - Grado di protezione - Protection index | IP66/67 |
| - Categoria di sovratensione - Impulse withstand category | II |

Caratteristiche

Characteristics

- Corpo in policarbonato trasparente
- Transparent polycarbonate body
- Contatti in lega di rame
- Copper alloy contacts
- Guarnizioni in neoprene/silicone
- Neoprene/silicone gaskets



| | | | |
|--|--|--|---|
|  fissaggio ad innesto snap-in fixing |  spessore lamiera di fissaggio fixing metal plate thickness 0,8-2 |  altezza centro lampada (da sopra la lamiera) lamp centre height (from the top of the metal plate) 34,5 |  rotore in PBT verde con scatti di... PBT green rotor with position of... |
|  serrafilo automatico ad 1 foro push-wire terminals with 1 hole |  sezione conduttori rigidi rigid conductor section 0,5-1 |  spelatura cavetti rigidi rigid wires stripping 10-11 |  protetto IP66/67 IP66/67 protected |
|  |  |  |  |

Marchi di qualità

Quality marks

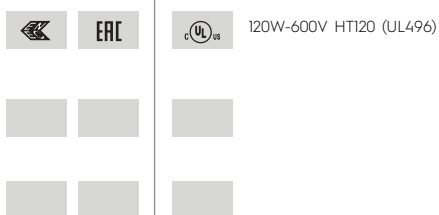

Direttive Europee

European directives

Conforme "RoHS"
"RoHS" compliant
Non soggetto alla "RAEE"
Not subject to "WEEE"

Pesi e confezioni

Weights and packaging

| Art. Codice prodotti Product references | g Peso netto Net weight | n° pz per sacco per bag | n° pz per scatola per box | n° pz per cartone per carton |
|---|-------------------------------|-------------------------------|---------------------------------|------------------------------------|
| 1880-G5/16-TR | 68,2 | | | 100 |
| | | | | |
| | | | | |
| | | | | |
| | | | | |
| | | | | |
| | | | | |
| | | | | |

Note

Notes