

1880/26

**PORTALAMPADE DOPPIO PROTETTO PER LAMPADE FLUORESCENTI LINEARI T8**  
**TWIN PROTECTED LAMPHOLDER FOR T8 FLUORESCENT LINEAR LAMPS**

**Dati tecnici**

*Technical data*









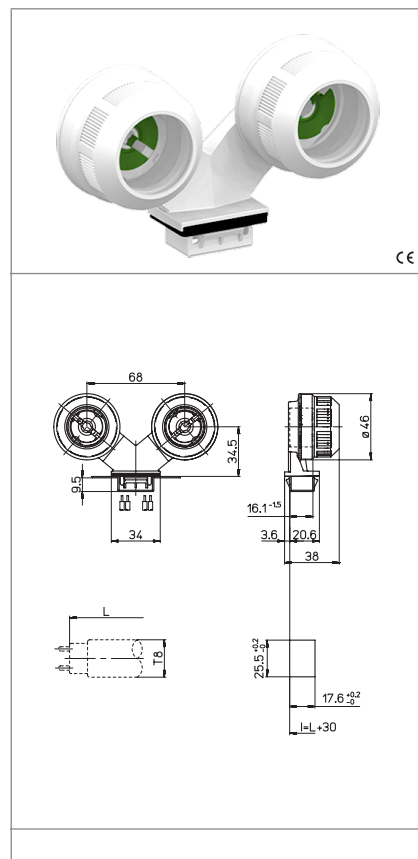



|   |               |
|---|---------------|
| - Attacco lampada<br>- Lamp Cap   | G13           |
| - Corrente e tensione nominale<br>- Rated current and voltage                         | 2A-500V       |
| - Temperatura massima di funzionamento (IEC)<br>- Maximum operating temperature (IEC) | T140<br>Tm110 |
| - Grado di protezione<br>- Protection index   | IP66/67       |
| - Categoria di sovratensione<br>- Impulse withstand category                          | II            |

**Caratteristiche**

*Characteristics*

- Corpo in policarbonato bianco e PBT bianco
- White polycarbonate and white PBT body
- Contatti in lega di rame
- Copper alloy contacts
- Guarnizioni in neoprene/silicone
- Neoprene/silicone gaskets



|  |   |  |   |
|--|---|--|---|
|  fissaggio ad innesto<br>snap-in fixing                            |  spessore lamiera di fissaggio<br>fixing metal plate thickness<br>0,8-2        |  altezza centro lampada (da sopra la lamiera)<br>lamp centre height (from the top of the metal plate)<br>34,5 |  rotore in PBT verde con scatti di...<br>PBT green rotor with position of... |
|  serrafilo automatico ad 1 foro<br>push-wire terminals with 1 hole |  sezione conduttori rigidi<br>rigid conductor section<br>0,5-1 mm <sup>2</sup> |  spelatura cavetti rigidi<br>rigid wires stripping<br>10-11   |  protetto IP66/67<br>IP66/67 protected                                       |
|    |    |   |    |

**Marchi di qualità**

*Quality marks*

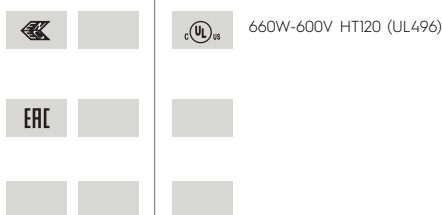

**Direttive Europee**

*European directives*

Conforme "RoHS"  
"RoHS" compliant  
Non soggetto alla "RAEE"  
Not subject to "WEEE"

**Pesi e confezioni**

*Weights and packaging*

| Art.<br>Codice prodotti<br>Product references | g<br>Peso netto<br>Net weight | n° pz<br>per sacco<br>per bag | n° pz<br>per scatola<br>per box | n° pz<br>per cartone<br>per carton |
|---|-------------------------------|-------------------------------|---------------------------------|------------------------------------|
| 1880/26                                       | 66,2                          |                               |                                 | 100                                |
|   |                               |                               |                                 |                                    |
|   |                               |                               |                                 |                                    |
|   |                               |                               |                                 |                                    |
|   |                               |                               |                                 |                                    |
|   |                               |                               |                                 |                                    |
|   |                               |                               |                                 |                                    |

**Note**

*Notes*