

1883/38

PORTALAMPADE DOPPIO PROTETTO PER LAMPADE FLUORESCENTI LINEARI T8 + TUBO DI PROTEZIONE, T12
TWIN PROTECTED LAMPHOLDER FOR T8 + COVER TUBE, T12 FLUORESCENT LINEAR LAMPS

Dati tecnici

Technical data









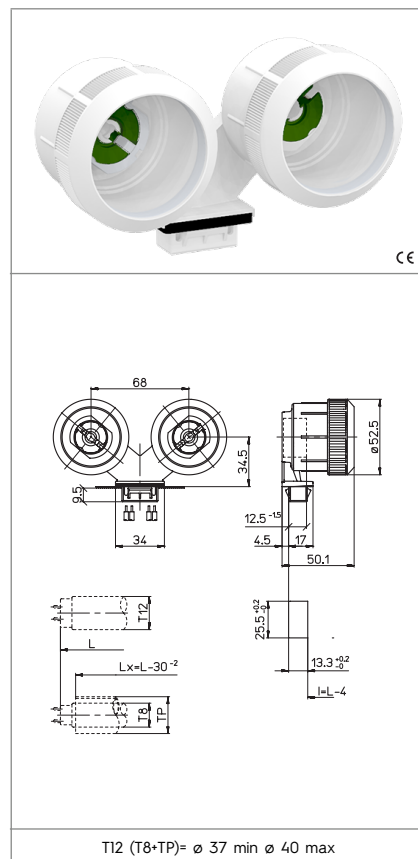



- Attacco lampada - Lamp Cap	G13
- Corrente e tensione nominale - Rated current and voltage	2A-500V
- Temperatura massima di funzionamento (IEC) - Maximum operating temperature (IEC)	T140 Tm110
- Grado di protezione - Protection index	IP66/67
- Categoria di sovratensione - Impulse withstand category	II

Caratteristiche

Characteristics

- Corpo in policarbonato bianco e PBT bianco
- White polycarbonate and white PBT body
- Contatti in lega di rame
- Copper alloy contacts
- Guarnizioni in neoprene/silicone
- Neoprene/silicone gaskets



 fissaggio ad innesto snap-in fixing	 spessore lamiera di fissaggio fixing metal plate thickness 0,8-2	 altezza centro lampada (da sopra la lamiera) lamp centre height (from the top of the metal plate) 34,5	 rotore in PBT verde con scatti di... PBT green rotor with position of...
 serrafilo automatico ad 1 foro push-wire terminals with 1 hole	 sezione conduttori rigidi rigid conductor section 0,5-1 mm ²	 spelatura cavetti rigidi rigid wires stripping 10-11	 protetto IP66/67 IP66/67 protected
			

Marchi di qualità

Quality marks

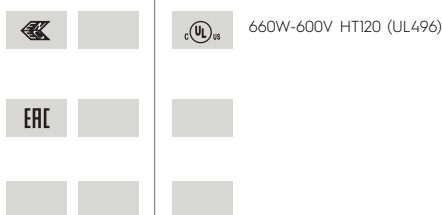

Direttive Europee

European directives

Conforme "RoHS"
"RoHS" compliant
Non soggetto alla "RAEE"
Not subject to "WEEE"

Pesi e confezioni

Weights and packaging

Art. Codice prodotti Product references	g Peso netto Net weight	n° pz per sacco per bag	n° pz per scatola per box	n° pz per cartone per carton
1883/38	88,6			100

Note

Notes