

1883/26

PORTALAMPADE DOPPIO PROTETTO PER LAMPADE FLUORESCENTI LINEARI T8
TWIN PROTECTED LAMPHOLDER FOR T8 FLUORESCENT LINEAR LAMPS

Dati tecnici

Technical data







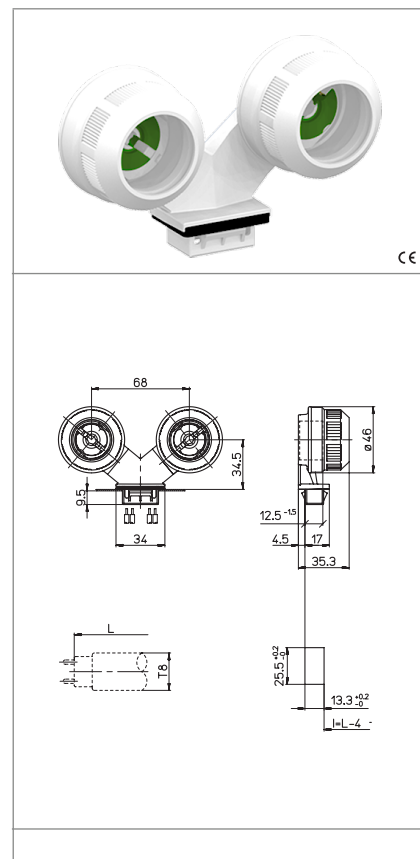

- Attacco lampada - Lamp Cap	G13
- Corrente e tensione nominale - Rated current and voltage	2A-500V
- Temperatura massima di funzionamento (IEC) - Maximum operating temperature (IEC)	T140 Tm110
- Grado di protezione - Protection index	IP66/67
- Categoria di sovratensione - Impulse withstand category	II

Caratteristiche

Characteristics

- Corpo in policarbonato bianco e PBT bianco
- White polycarbonate and white PBT body
- Contatti in lega di rame
- Copper alloy contacts
- Guarnizioni in neoprene/silicone
- Neoprene/silicone gaskets



 fissaggio ad innesto <i>snap-in fixing</i>	 spessore lamiera di fissaggio <i>fixing metal plate thickness</i> 0,8-2	 altezza centro lampada (da sopra la lamiera) <i>lamp centre height (from the top of the metal plate)</i> 34,5	 rotore in PBT verde con scatti di... <i>PBT green rotor with position of...</i> 90°
 serrafilo automatico ad 1 foro <i>push-wire terminals with 1 hole</i>	 sezione conduttori rigidi <i>rigid conductor section</i> 0,5-1	 spelatura cavetti rigidi <i>rigid wires stripping</i> 10-11	 protetto IP66/67 <i>IP66/67 protected</i>

Marchi di qualità

Quality marks

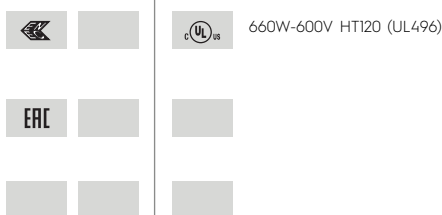

Direttive Europee

European directives

Conforme "RoHS"
"RoHS" compliant
Non soggetto alla "RAEE"
Not subject to "WEEE"

Pesi e confezioni

Weights and packaging

Art. Codice prodotti Product references	g Peso netto Net weight	n° pz per sacco per bag	n° pz per scatola per box	n° pz per cartone per carton
1883/26	66,2			100

Note

Notes