

1115

CUFFIA DI COPERTURA PORTALAMPADE
PROTECTION COVER FOR LAMP HOLDERS

Dati tecnici
Technical data

Caratteristiche
Characteristics

in PBT bianco
in white PBT

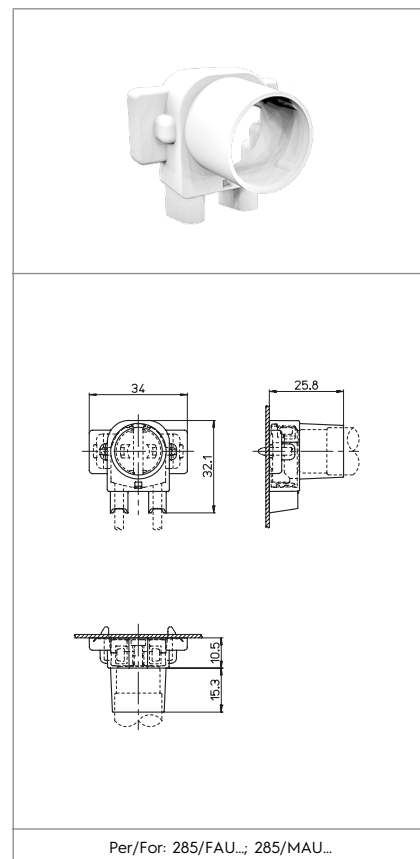

	IP40 protetto IP40 IP40 protected		
			
			

Marchi di qualità
Quality marks

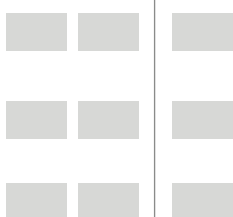

Direttive Europee
European directives

Conforme "RoHS"
"RoHS" compliant
Non soggetto alla "RAEE"
Not subject to "WEEE"

Pesi e confezioni
Weights and packaging

Art. Codice prodotti Product references	g Peso netto Net weight	n° pz per sacco per bag	n° pz per scatola per box	n° pz per cartone per carton
1115	3,1	1000		

Note

Notes