

## 3602/V-GR

### PRESA DI CONNESSIONE PROTETTA PROTECTED CONNECTION SOCKET

#### Dati tecnici

##### Technical data





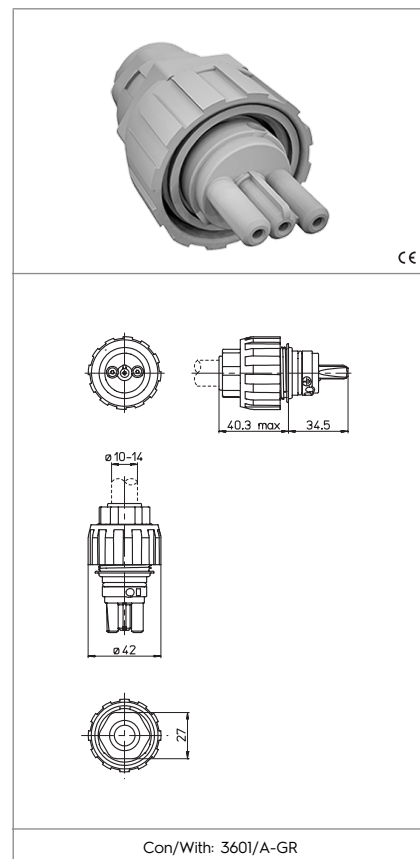

- Poli - Poles	2P+E
- Corrente e tensione nominale - Rated current and voltage	16A-250V
- Temperatura massima di funzionamento (IEC) - Maximum operating temperature (IEC)	T120
- Grado di protezione - Protection index	IP66
- Cat. sovratensione / Grado di inquinamento - Impulse withstand cat. / Pollution degree	III / 2

#### Caratteristiche

##### Characteristics

- Corpo in poliammide grigio  
- Polyamide body .../GR= grey
- Contatti in ottone argentato  
- Silver plated brass contacts



 senza fissaggio without fixing	 serrafilo con vite e morsetto screw terminals	 sezione conduttore flessibile con fascetta section of the flexible conductor with ferrule	 sezione conduttori rigidi rigid conductor section
 spelatura cavetti rigidi e flessibili con fascetta rigid and flexible with ferrule wires stripping	 adatto per tensione di accensione ad impulsi fino a... suitable for impulse ignition voltage up to...	 protetto IP66 IP66 protected	

#### Marchi di qualità

##### Quality marks

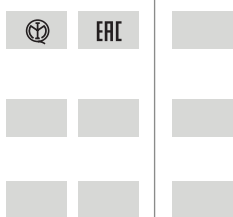

#### Direttive Europee

##### European directives

Conforme "RoHS"  
"RoHS" compliant

#### Pesi e confezioni

##### Weights and packaging

Art. Codice prodotti Product references	g Peso netto Net weight	n° pz per sacco per bag	n° pz per scatola per box	n° pz per cartone per carton
3602/V-GR	39,4		100	

**Note** - La temperatura massima di funzionamento T è la massima temperatura ambiente alla quale il connettore può funzionare con il valore di corrente nominale indicato (EN/IEC61984). Limite di temperatura inferiore / superiore è: -10 °C / +150 °C (EN/IEC61984).

**Notes** - The maximum operating temperature T is the maximum ambient temperature for the connector working at the rated current value indicated (EN/IEC61984). Temperature lower/upper limits: -10 °C / +150 °C (EN/IEC61984).