

1675/A

MORSETTO PER APPARECCHI DI ILLUMINAZIONE
TERMINAL BLOCK FOR LIGHTING FIXTURES

Dati tecnici

Technical data

- Poli - Poles	4P+E
- Corrente e tensione nominale - Rated current and voltage	16A-450V
- Temperatura massima di funzionamento (IEC) - Maximum operating temperature (IEC)	T85
- Grado di protezione - Protection index	IP20

Caratteristiche

Characteristics







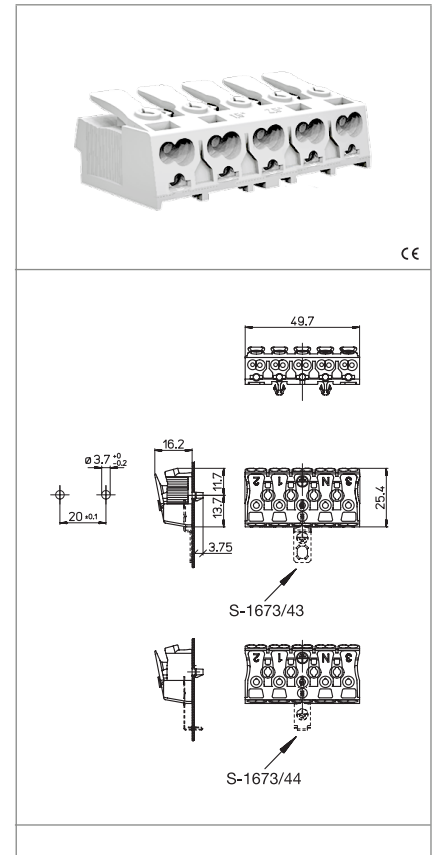

- Corpo in policarbonato bianco
- White polycarbonate body
- Corpo serrafilo in rame stagnato
- Internal part in tin plated copper

foro "c": usare solo conduttori solidi
"c" hole: solid conductors only

*Nelle versioni provviste di contatto di terra, il foro per cavi 0,5-0,75 mm² del polo di terra non può essere utilizzato.

*In versions provided with earth contact the 0.5-0.75mm² terminal hole on the earth pole cannot be used.



 fissaggio ad innesto push-in fixing	 spessore lamiera di fissaggio fixing metal plate thickness 0,6-1,2	 sezione conduttore cordato solido e flessibile stranded, solid and flexible conductor section 0,5-2,5 0,75-2,5 1,5-2,5	 isolato in classe II class II insulated 250V
 serrafilo automatico a 3 fori push-wire terminals with 3 holes 0,5-1,5 0,5-2,5 0,5-0,75*	 spelatura cavetti cordati, solidi e flessibili stranded, solid and flexible wires stripping 0,75-1+8-9 1,5-2,5+9-10	 serrafilo automatico a 2 fori push-wire terminals with 2 holes 0,75-2,5	 entrata: automatico uscita: automatico input side: push wire output side: push wire
	 spelatura cavetti wires stripping 0,5-1+8-9 1,5-2,5+9-10	 1699	

Marchi di qualità

Quality marks

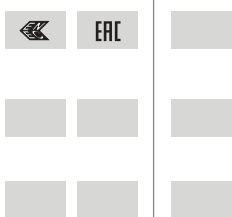

Direttive Europee

European directives

Conforme "RoHS"
"RoHS" compliant
Non soggetto alla "RAEE"
Not subject to "WEEE"

Pesi e confezioni

Weights and packaging

Art. Codice prodotti Product references	g Peso netto Net weight	n° pz per sacco per bag	n° pz per scatola per box	n° pz per cartone per carton
1675/A	13,1			500

Note

Notes

Note

Note

SERRAFILO AUTOMATICO DEGLI ART. 1673/... - 1675/... - ET..

Sezione dei cavetti per i serrafilo in entrata

Solidi:	0,5-2,5 mm ² (1673/...)
	0,5-2,5 mm ² (1675/..., ET...)
Cordati:	0,5-2,5 mm ² (1673/...)
	0,75-2,5 mm ² (1675/..., ET...)
Flessibili:	1,5-2,5 mm ²

Sezione dei cavetti per i serrafilo in uscita

Solidi:	(a) 0,5-1,5 mm ²
	(b) 0,5-2,5 mm ²
	(c) 0,5-0,75 mm ² *

Spelatura

- con sezioni 0,5-1 mm²: 8-9 mm
- con sezioni 1,5-2,5 mm²: 9-10 mm
- con sezioni 0,5-0,75 mm²: 9-11 mm (1673/...) *

PUSH WIRE TERMINALS OF ART. 1673/... - 1675/...- ET...

Section of wires for input side terminals

Solid:	0,5-2,5 mm ² (1673/...)
	0,5-2,5 mm ² (1675/..., ET...)
Stranded:	0,5-2,5 mm ² (1673/...)
	0,75-2,5 mm ² (1675/..., ET...)
Flexible:	1,5-2,5 mm ²

Section of wires for output side terminals

Solid:	(a) 0,5-1,5 mm ²
	(b) 0,5-2,5 mm ²
	(c) 0,5-0,75 mm ² *

Stripping

- cable with 0,5-1 mm² sections: 8-9 mm
- cable with 1,5-2,5 mm² sections: 9-10 mm
- cable with 0,5-0,75 mm² sections: 9-11 mm (1673/...) *

SERRAFILO IN ENTRATA
INPUT SIDE TERMINALS

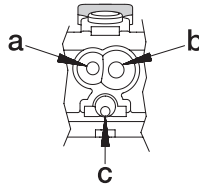
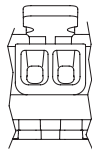

SERRAFILO IN USCITA
OUTPUT SIDE TERMINALS

* Nelle versioni provviste di contatto di terra, il foro per cavi 0,5-0,75mm² del polo di terra non può essere utilizzato.

* In versions provided with earth contact the 0.5-0.75mm² terminal hole on the earth pole cannot be used.