

## 1675/SP/43

### MORSETTO PER APPARECCHI DI ILLUMINAZIONE TERMINAL BLOCK FOR LIGHTING FIXTURES

#### Dati tecnici

##### Technical data

- Poli - Poles	4P+E
- Corrente e tensione nominale - Rated current and voltage	16A-450V
- Temperatura massima di funzionamento (IEC) - Maximum operating temperature (IEC)	T85
- Grado di protezione - Protection index	IP20

#### Caratteristiche









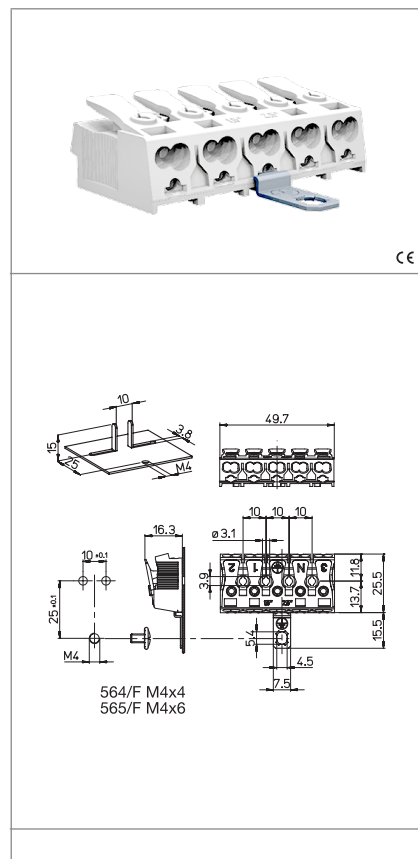



##### Characteristics

- Corpo in policarbonato bianco  
– White polycarbonate body
- Corpo serrafilo in rame stagnato  
– Internal part in tin plated copper
- Connessione di terra in acciaio zincato  
– Earth connection in zinc plated steel

foro "c": usare solo conduttori solidi  
"c" hole: solid conductors only

\*Nelle versioni provviste di contatto di terra, il foro per cavi 0,5-0,75 mm<sup>2</sup> del polo di terra non può essere utilizzato.  
\*In versions provided with earth contact the 0.5-0.75mm<sup>2</sup> terminal hole on the earth pole cannot be used.



 fissaggio con vite screw fixing	 fissaggio su spine fixing into pins	 sezione conduttore cordato solido e flessibile stranded, solid and flexible conductor section	 isolato in classe II class II insulated
 serrafilo automatico a 3 fori push-wire terminals with 3 holes	 spelatura cavetti cordati, solidi e flessibili stranded, solid and flexible wires stripping	 serrafilo automatico a 2 fori push-wire terminals with 2 holes	 entrata: automatico uscita: automatico input side: push wire output side: push wire
 serrafilo automatico a 2 fori push-wire terminals with 2 holes	 spelatura cavetti wires stripping	 564/F 565/F	 1699

#### Marchi di qualità

##### Quality marks

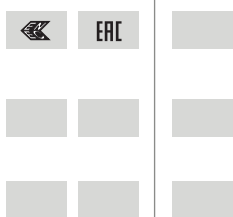

#### Direttive Europee

##### European directives

Conforme "RoHS"  
"RoHS" compliant  
Non soggetto alla "RAEE"  
Not subject to "WEEE"

#### Pesi e confezioni

##### Weights and packaging

Art. Codice prodotti Product references	g Peso netto Net weight	n° pz per sacco per bag	n° pz per scatola per box	n° pz per cartone per carton
1675/SP/43	13,9	500		

#### Note

##### Notes

## Note

Note

### SERRAFILO AUTOMATICO DEGLI ART. 1673/... - 1675/... - ET..

#### Sezione dei cavetti per i serrafilo in entrata

Solidi:	0,5-2,5 mm <sup>2</sup> (1673/...)
	0,5-2,5 mm <sup>2</sup> (1675/..., ET..)
Cordati:	0,5-2,5 mm <sup>2</sup> (1673/...)
	0,75-2,5 mm <sup>2</sup> (1675/..., ET..)
Flessibili:	1,5-2,5 mm <sup>2</sup>

#### Sezione dei cavetti per i serrafilo in uscita

Solidi:	(a) 0,5-1,5 mm <sup>2</sup>
	(b) 0,5-2,5 mm <sup>2</sup>
	(c) 0,5-0,75 mm <sup>2</sup> *

#### Spelatura

- con sezioni 0,5-1 mm<sup>2</sup>: 8-9 mm
- con sezioni 1,5-2,5 mm<sup>2</sup>: 9-10 mm
- con sezioni 0,5-0,75 mm<sup>2</sup>: 9-11 mm (1673/...) \*

### PUSH WIRE TERMINALS OF ART. 1673/... - 1675/...- ET...

#### Section of wires for input side terminals

Solid:	0,5-2,5 mm <sup>2</sup> (1673/...)
	0,5-2,5 mm <sup>2</sup> (1675/..., ET..)
Stranded:	0,5-2,5 mm <sup>2</sup> (1673/...)
	0,75-2,5 mm <sup>2</sup> (1675/..., ET..)
Flexible:	1,5-2,5 mm <sup>2</sup>

#### Section of wires for output side terminals

Solid:	(a) 0,5-1,5 mm <sup>2</sup>
	(b) 0,5-2,5 mm <sup>2</sup>
	(c) 0,5-0,75 mm <sup>2</sup> *

#### Stripping

- cable with 0,5-1 mm<sup>2</sup> sections: 8-9 mm
- cable with 1,5-2,5 mm<sup>2</sup> sections: 9-10 mm
- cable with 0,5-0,75 mm<sup>2</sup> sections: 9-11 mm (1673/...) \*

**SERRAFILO IN ENTRATA**  
**INPUT SIDE TERMINALS**

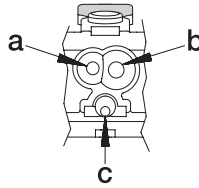
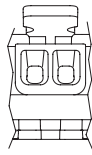

**SERRAFILO IN USCITA**  
**OUTPUT SIDE TERMINALS**

\* Nelle versioni provviste di contatto di terra, il foro per cavi 0,5-0,75mm<sup>2</sup> del polo di terra non può essere utilizzato.

\* In versions provided with earth contact the 0.5-0.75mm<sup>2</sup> terminal hole on the earth pole cannot be used.