

218/X
218/X-S

218/X-TF
218/X-S-TF

218/X-TF-FEP
218/X-S-TF-FEP

PORTALAMPADE PER LAMPADE AD INCANDESCENZA TUNGSTENO ALOGENE A BASSISSIMA TENSIONE
LAMPHOLDER FOR EXTRA LOW VOLTAGE TUNGSTEN HALOGEN INCANDESCENT LAMPS

Dati tecnici

Technical data

- Attacco lampada - Lamp Cap	G4 GY4 G5.3 GX5.3
- Corrente e tensione nominale - Rated current and voltage	10A-24V
- Temperatura massima di funzionamento (IEC) - Maximum operating temperature (IEC)	T350
- Grado di protezione - Protection index	IP20
- Categoria di sovratensione - Impulse withstand category	II

Caratteristiche





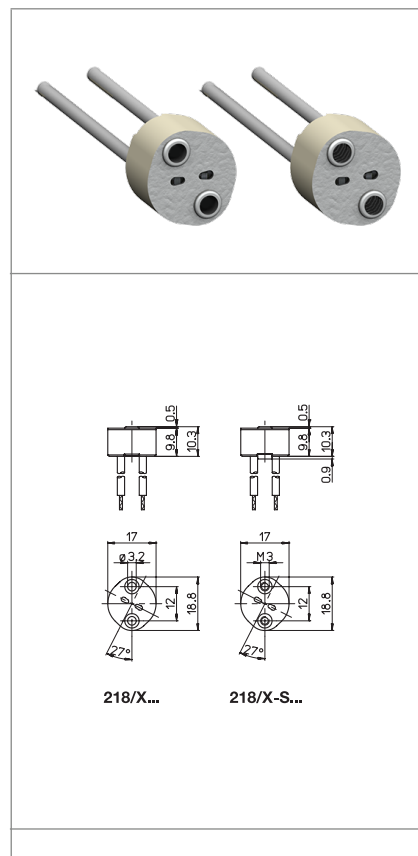

Characteristics

CONNETTORI CON GY4 GX5.3 GZ6.35
CONNECTORS WITH GY4 GX5.3 GZ6.35

...-S= con bussole filettate M3
...-S= with M3 threaded bushes

- Corpo in steatite
- Steatite body
- Doppi contatti in nichel
- Nickel twin contacts



 fissaggio con vite screw fixing	 conduttore saldato elettricamente al contatto conductor electrically spot-welded to the contact	 sezione conduttore flessibile con fascetta section of the flexible conductor with ferrule	 sezione conduttore flessibile con fascetta section of the flexible conductor with ferrule
 sezione conduttore flessibile con fascetta section of the flexible conductor with ferrule	 lunghezza cavetto flessibile flexible wire length		

Marchi di qualità

Quality marks

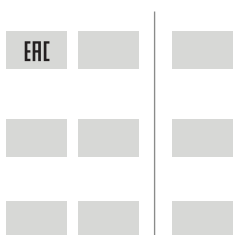

Direttive Europee

European directives

Conforme "RoHS"
"RoHS" compliant
Non soggetto alla "RAEE"
Not subject to "WEEE"

Pesi e confezioni

Weights and packaging

Art. Codice prodotti Product references	g Peso netto Net weight	n° pz per sacco per bag	n° pz per scatola per box	n° pz per cartone per carton
218/X	9,3		200	
218/X-TF				
218/X-TF-FEP				
218/X-S				
218/X-S-TF				
218/X-S-TF-FEP				

Note

Notes

Note

Note

ARTICOLI IN STEATITE

I particolari in steatite, in fase di cottura, subiscono variazioni dimensionali tra lotto e lotto di produzione perciò occorre fare riferimento alle tolleranze di lavorazione stabilite dalla norma DIN 40680, valori medi, rispetto alle quote nominali indicate a catalogo.

ARTICLES IN STEATITE

Products moulded in steatite undergo dimensional changes during the high temperature curing process. Therefore reference must be made to the tolerance stated in DIN 40680, middle values referred to the nominal values stated in the catalogue.

DIMENSIONI DIMENSIONS	Tolleranza/Tolerance
	DIN40680
Fino a/Up to 4	±0,15
Da/From 4,1 a/to 6	±0,20
Da/From 6,1 a/to 8	±0,25
Da/From 8,1 a/to 10	±0,30
Da/From 10,1 a/to 13	±0,35
Da/From 13,1 a/to 16	±0,40
Da/From 16,1 a/to 20	±0,45
Da/From 20,1 a/to 25	±0,50
Da/From 25,1 a/to 30	±0,55
Da/From 30,1 a/to 35	±0,60
Da/From 35,1 a/to 40	±0,65
Da/From 40,1 a/to 45	±0,70
Da/From 45,1 a/to 50	±0,80
Da/From 50,1 a/to 55	±0,90
Da/From 55,1 a/to 60	±1,00