

3601/V-GR

SPINA DI CONNESSIONE PROTETTA PROTECTED CONNECTION PLUG

Dati tecnici

Technical data





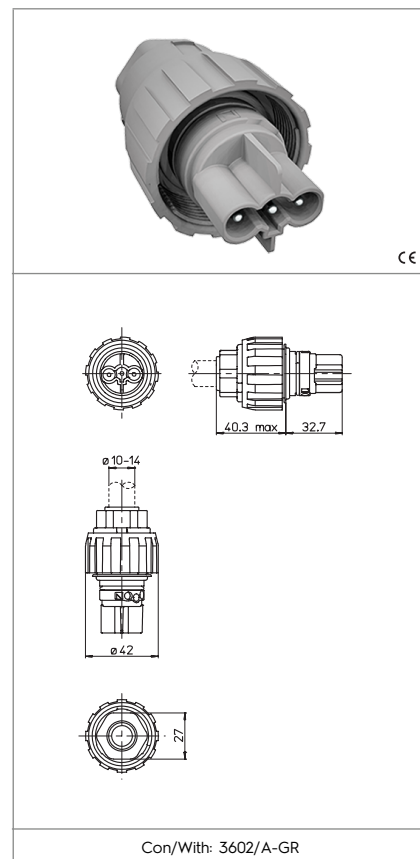

- Poli - Poles	2P+E
- Corrente e tensione nominale - Rated current and voltage	16A-250V
- Temperatura massima di funzionamento (IEC) - Maximum operating temperature (IEC)	T120
- Grado di protezione - Protection index	IP66
- Cat. sovratensione / Grado di inquinamento - Impulse withstand cat. / Pollution degree	III / 2

Caratteristiche

Characteristics

- Corpo in poliammide grigio
– Polyamide body .../GR= grey
- Contatti in ottone argentato
– Silver plated brass contacts



 senza fissaggio without fixing	 serrafilo con vite e morsetto screw terminals	 sezione conduttore flessibile con fascetta section of the flexible conductor with ferrule	 sezione conduttori rigidi rigid conductor section
 spelatura cavetti rigidi e flessibili con fascetta rigid and flexible with ferrule wires stripping	 adatto per tensione di accensione ad impulsi fino a... suitable for impulse ignition voltage up to...	 protetto IP66 IP66 protected	

Marchi di qualità

Quality marks

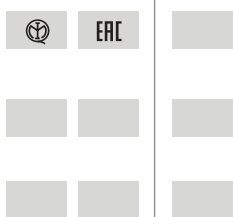

Direttive Europee

European directives

Conforme "RoHS"
"RoHS" compliant

Pesi e confezioni

Weights and packaging

Art. Codice prodotti Product references	g Peso netto Net weight	n° pz per sacco per bag	n° pz per scatola per box	n° pz per cartone per carton
3601/V-GR	39,5		100	

Note - La temperatura massima di funzionamento T è la massima temperatura ambiente alla quale il connettore può funzionare con il valore di corrente nominale indicato (EN/IEC61984). Limite di temperatura inferiore / superiore è: -10 °C / +150 °C (EN/IEC61984).

Notes - The maximum operating temperature T is the maximum ambient temperature for the connector working at the rated current value indicated (EN/IEC61984). Temperature lower/upper limits: -10 °C / +150 °C (EN/IEC61984).