

2602/VMB-M-2

2602/VMB-SM-2

2602/VMN-M-2

2602/VMN-SM-2

## PRESE DI CONNESSIONE CON COPERTURA E GANCIO CONNECTION SOCKETS AND LOCKING DEVICE

### Dati tecnici

#### Technical data

- Poli - Poles	2P
- Corrente e tensione nominale - Rated current and voltage	16A-250V
- Temperatura massima di funzionamento (IEC) - Maximum operating temperature (IEC)	T120
- Grado di protezione - Protection index	IP20
- Cat. sovratensione / Grado di inquinamento - Impulse withstand cat. / Pollution degree	III / 2



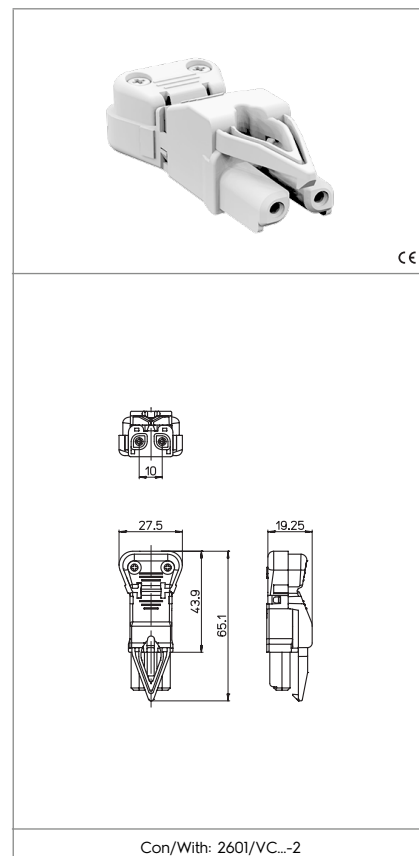

### Caratteristiche

#### Characteristics

- Corpo in poliammide .../B= bianco .../N= nero  
– Polyamide body .../B= white .../N= black
- Contatti in ottone argentato  
– Silver plated brass contacts



Con/With: 2601/VC...-2

 senza fissaggio without fixing	 fissaggio con vite screw fixing	 serrafilo con vite e morsetto screw terminals	 sezione conduttore flessibile section of the flexible conductor
 sezione conduttore flessibile con fascetta section of the flexible conductor with ferrule	 sezione conduttori rigidi rigid conductor section	 spelatura cavetti rigidi e flessibili (con o senza fascetta) rigid and flexible wires stripping (with or without ferrule)	 adatto per tensione di accensione ad impulsi fino a... suitable for impulse ignition voltage up to...
 con cappuccio e viti montati with cover and screws assembled	 con cappuccio e viti smontati with cover and screws disassembled		

### Marchi di qualità

#### Quality marks

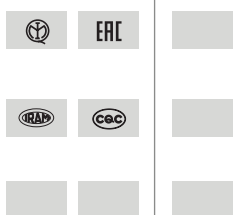

### Direttive Europee

#### European directives

Conforme "RoHS"  
"RoHS" compliant

### Pesi e confezioni

#### Weights and packaging

Art. Codice prodotti Product references	g Peso netto Net weight	n° pz per sacco per bag	n° pz per scatola per box	n° pz per cartone per carton
2602/VMB-M-2	12,5	500		
2602/VMB-SM-2	12,5	500		
2602/VMN-M-2	12,5	500		
2602/VMN-SM-2	12,5	500		

**Note** - La temperatura massima di funzionamento T è la massima temperatura ambiente alla quale il connettore può funzionare con il valore di corrente nominale indicato (EN/IEC61984). Limite di temperatura inferiore / superiore è: -10 °C / +150 °C (EN/IEC61984).

**Notes** - The maximum operating temperature T is the maximum ambient temperature for the connector working at the rated current value indicated (EN/IEC61984). Temperature lower/upper limits: -10 °C / +150 °C (EN/IEC61984).