

1600/AB

1600/AN

GANCI DI SICUREZZA
SAFETY HOOKS

Dati tecnici

Technical data

Caratteristiche

Characteristics

.../B= bianco .../N= nero

.../B= white .../N= black

– Corpo in poliammide

– Polyamide body

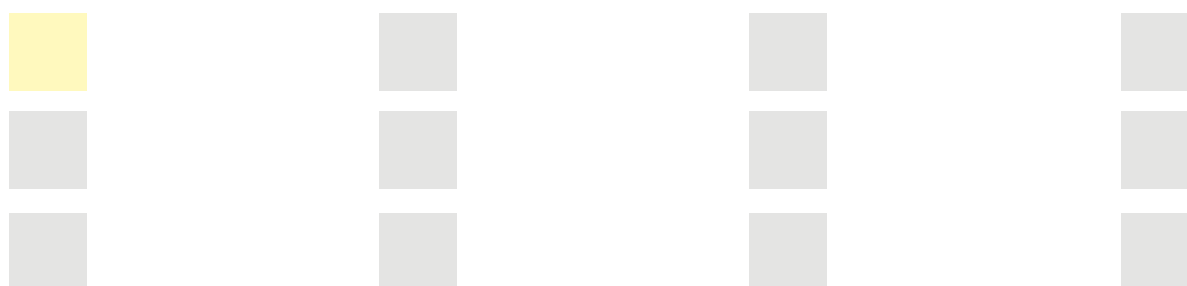
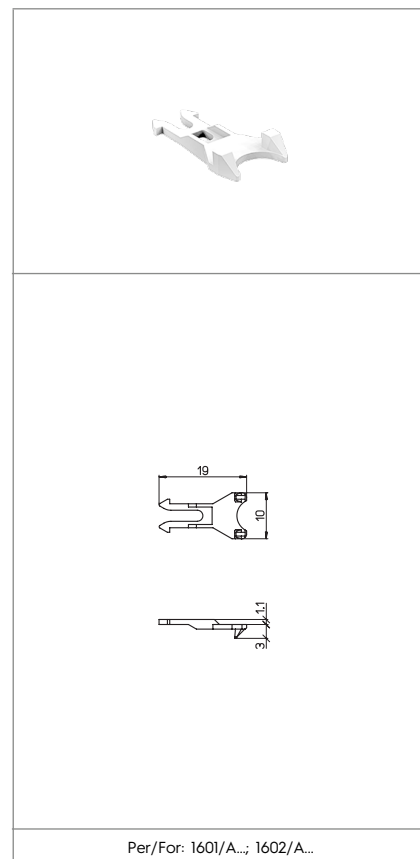

Marchi di qualità

Quality marks

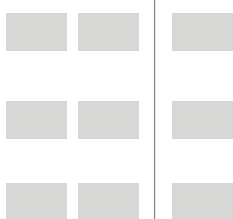

Direttive Europee

European directives

Conforme "RoHS"
"RoHS" compliant

Pesi e confezioni

Weights and packaging

Art. Codice prodotti Product references	g Peso netto Net weight	n° pz per sacco per bag	n° pz per scatola per box	n° pz per cartone per carton
1600/AB	0,2	2000		
1600/AN	0,2	2000		

Note

Notes