

3701/V

3701/V-N

SPINA DI CONNESSIONE PROTETTA
PROTECTED CONNECTION PLUG

Dati tecnici

Technical data

- Poli - Poles	2P+E
- Corrente e tensione nominale - Rated current and voltage	16A-250V
- Temperatura massima di funzionamento (IEC) - Maximum operating temperature (IEC)	T120
- Grado di protezione - Protection index	IP66/68
- Cat. sovratensione / Grado di inquinamento - Impulse withstand cat. / Pollution degree	III / 2

Caratteristiche







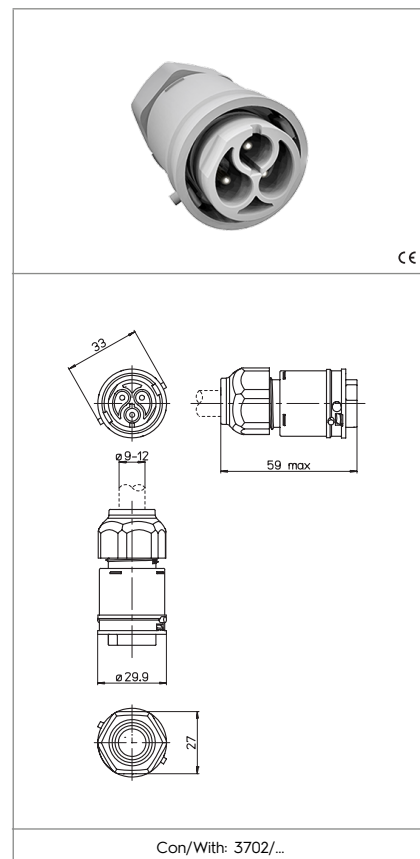

Characteristics

- Corpo in poliammide grigio chiaro
- Light grey polyamide body

...V= grigio chiaro ...V-N= nero
...V= light grey ...V-N= black









- Contatti in ottone argentato
- Silver plated brass contacts



 senza fissaggio without fixing	 serrafilo con vite e morsetto screw terminals	 sezione conduttore flessibile con fascetta section of the flexible conductor with ferrule	 sezione conduttori rigidi rigid conductor section
 spelatura cavetti rigidi e flessibili con fascetta rigid and flexible with ferrule wires stripping	 adatto per tensione di accensione ad impulsi fino a... suitable for impulse ignition voltage up to...	 protetto IP66/68 (3m/2h) IP66/68 protected (3m/2h)	 3700/C...
 S-3700/121			

Marchi di qualità

Quality marks

			600V-15A(AWG14) 10A(AWG16) 7A(AWG18) T105
			
			

Direttive Europee

European directives

Conforme "RoHS"
"RoHS" compliant

Pesi e confezioni

Weights and packaging

Art. Codice prodotti Product references	g Peso netto Net weight	n° pz per sacco per bag	n° pz per scatola per box	n° pz per cartone per carton
3701/V	24,8		200	500
3701/V-N	24,8		200	500

Note - La temperatura massima di funzionamento T è la massima temperatura ambiente alla quale il connettore può funzionare con il valore di corrente nominale indicato (EN/IEC61984). Limite di temperatura inferiore / superiore è: -10 °C / +150 °C (EN/IEC61984).

Notes - The maximum operating temperature T is the maximum ambient temperature for the connector working at the rated current value indicated (EN/IEC61984). Temperature lower/upper limits: -10 °C / +150 °C (EN/IEC61984).

AVVERTENZE E ISTRUZIONI DI MONTAGGIO CONNETTORI PROTETTI IP66/68 2-3 POLI

I connettori devono essere collegati al cavo in assenza di tensione. Il cavo di alimentazione deve sempre essere collegato al connettore presa 3702/...

I connettori per fissaggio a parete art. 3701/A... e 3702/A... hanno il serrafilo automatico a 2 fori (0,5-2,5 mm²) che accetta due cavetti per ogni polo: si devono utilizzare cavetti di sezione adeguata alla corrente per l'eventuale collegamento passante e si possono utilizzare cavetti di sezione inferiore per derivare l'alimentazione dell'apparecchio di illuminazione.

I connettori art. 3701/... e 3702/... non devono essere utilizzati come sostituzione di prese e spine domestiche.

CAVI UTILIZZABILI:

- FG7OR: 2X1,5 mm² ; 2x2,5 mm²; 3X1,5 mm² ; 3x2,5 mm²
- FROR: 2X1,5 mm² ; 2x2,5 mm²; 3X1,5 mm² ; 3x2,5 mm²
- H05VV-F: 2x2,5 mm²; 3X1,5 mm² ; 3x2,5 mm²
- H07RN-F: 2x1 mm²; 2x2,5mm²; 3X1,5 mm² ; 3x2,5 mm²
- SIHF: 2x2,5 mm²; 3x2,5 mm²
- AWG14: 2X; 3X
- AWG16: 2X; 3X
- AWG18: 2X; 3X

CORRETTO ACCOPPIAMENTO CORPO/GUSCIO

3701/A...: corpo spina (1) + guscio con pin di fissaggio (2)

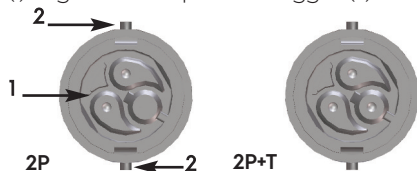

3701/V...: corpo spina (1) + guscio con pin di fissaggio (2) e bloccacavo

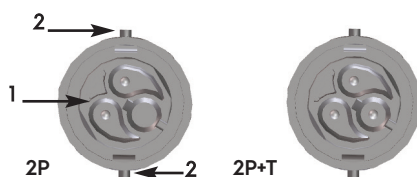

3702/A...: corpo presa (3) con finestre di aggancio (4)

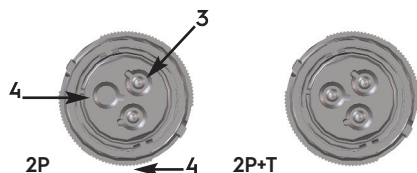

3702/V...: presa (3) con cave di fissaggio (4) e bloccacavo

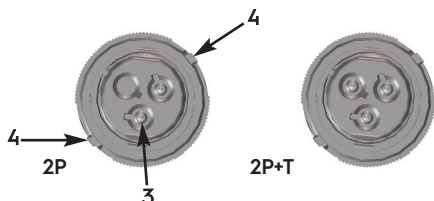

WARNINGS AND MOUNTING INSTRUCTIONS FOR IP66/68 2-3 POLES CONNECTORS

The connectors must be connected to the cable out of voltage. The supply cable must be always connected to the connection socket. 3702/...

Connectors for the panel mounting art. 3701/A... and 3702/A... have 2 holes (0,5-2,5 mm²) push wires terminals which accept two wires for each pole: wires with a suitable section for the current involved must be used for the eventual passing through connection and wires with reduced section can be used to supply the internal circuit of the lighting fitting.

The connectors art. 3701/..., 3702/... must not be used as replacement of domestic sockets and plugs.

SUITABLE CABLES:

- FG7OR: 2X1,5 mm² ; 2x2,5 mm²; 3X1,5 mm² ; 3x2,5 mm²
- FROR: 2X1,5 mm² ; 2x2,5 mm²; 3X1,5 mm² ; 3x2,5 mm²
- H05VV-F: 2x2,5 mm²; 3X1,5 mm² ; 3x2,5 mm²
- H07RN-F: 2x1 mm²; 2x2,5mm²; 3X1,5 mm² ; 3x2,5 mm²
- SIHF: 2x2,5 mm²; 3x2,5 mm²
- AWG14: 2X; 3X
- AWG16: 2X; 3X
- AWG18: 2X; 3X

RIGHT BODY/SHELL MOUNTING

3701/A...: plug body (1) + shell with fixing pins (2)

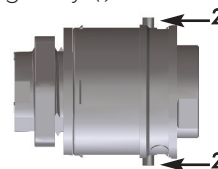

3701/V...: plug body (1) + shell with fixing pins (2) and gland

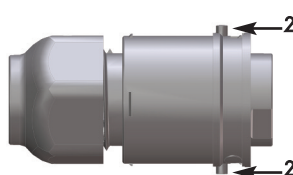

3702/A...: plug body (3) with openings for clamping (4)

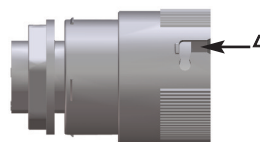

3702/V...: socket (3) with holes for fixing (4) and gland

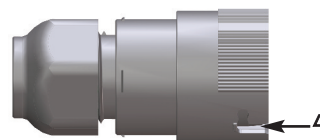

ISTRUZIONI DI MONTAGGIO PER CONNETTORI CON SERRAFILO A VITE

Lunghezze di sguainatura del cavo e spelatura dei conduttori

MOUNTING INSTRUCTION FOR CONNECTORS WITH SCREW TERMINALS

Cable and conductors stripping lengths

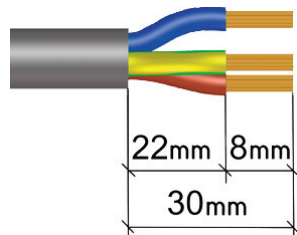

Connessione dei conduttori

Inserire il cavo (4) attraverso il dado bloccacavo (1), la guarnizione (2) e il corpo (3).

Wires connection

Insert the cable (4) through the nut of the gland (1), the gasket (2) and the body (3).

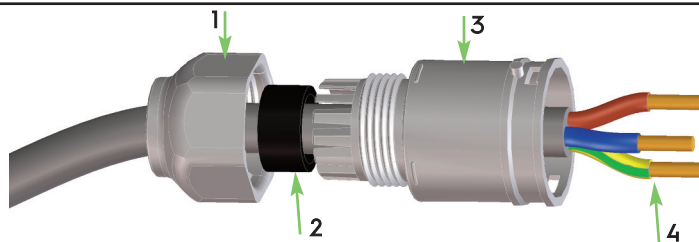

Collegare i conduttori ai serrafili a vite del frutto (5) ed inserirlo nel corpo fino a quando i ganci scattano nelle apposite aperture (figure A e B).

Connect the conductors into the screw terminals (5) and insert the module into the body until the hooks are released into suitable openings (pic. A, B).

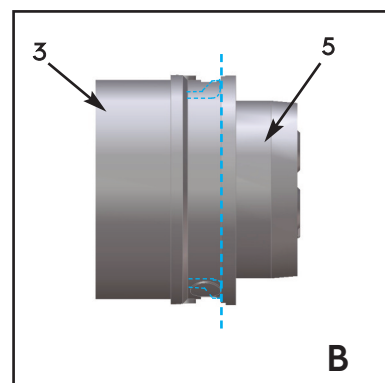
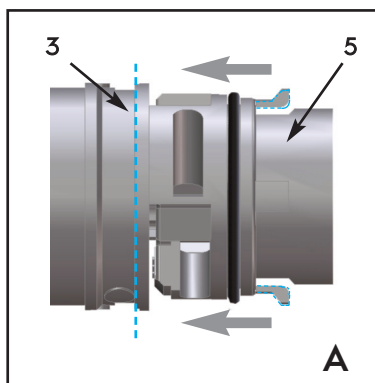
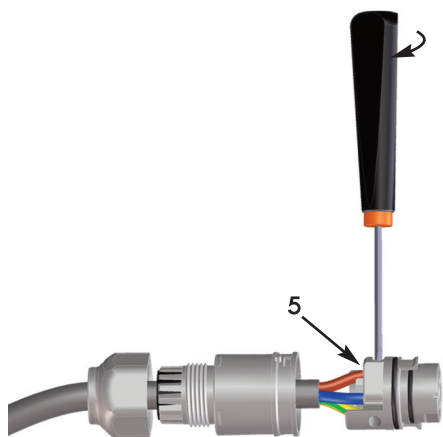

ATTENZIONE L'accoppiamento tra le due parti (3, 5) è possibile solo in una posizione.

Ruotare i due componenti fino a quando viene permesso l'inserimento (i ganci devono essere allineati alle relative finestre di aggancio).

WARNING The coupling of the two parts (3, 5) is possible in a unique position only.

Rotate the two component until they can couple (hooks must be aligned with openings for clamping).

Avvicinare il dado (1) al corpo del connettore.

Place the nut (1) next to the connector body.

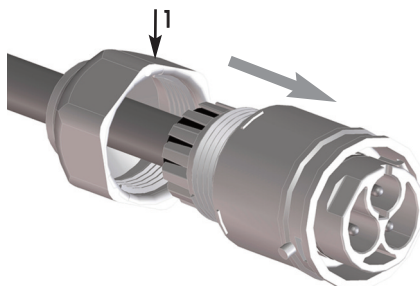

Avvitare il dado (1) al corpo (3) in modo da bloccare il cavo e stringere la guarnizione. Il dado (1) va girato con una chiave (coppia di serraggio 2.5 Nm) tenendo ben fermo il corpo (3).

Tighten the nut (1) on the body (3) to lock the cable and to tighten the gasket. The nut (1) is turned by wrench spanner (tightening torque 2.5Nm) keeping firm the body (3).



ATTENZIONE

Per assicurare il grado di protezione non deve essere applicata alla connessione nessuna forza torcente (es. non attaccare pesi al cavo, etc.).

CAUTION

To ensure protection category do not expose the connection to any bending force (e.g. do not attach loads to the cable, etc.).



N.B.: il raggio di curvatura del cavo di alimentazione deve essere almeno 4 volte il valore del diametro del cavo.

N.B.: The minimum bending radius for conductors has to be more than 4 times the conductor diameter.

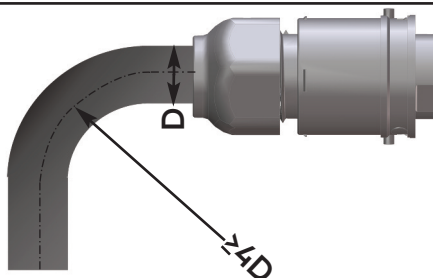

CONNETTORI PER FISSAGGIO A PARETE CON SERRAFILO AUTOMATICO

Connessione dei conduttori:

Le connessioni automatiche accettano conduttori rigidi con sezioni da 0,5 a 2,5 mm².

La spelatura sui conduttori deve essere 11-12 mm.

Istruzioni di montaggio dei connettori a parete

Inserire il corpo del connettore "A", con la guarnizione "AI" già montata, nel foro "B", tenendo presente la posizione del piano di riferimento che evita la rotazione del corpo durante l'avvitamento del dado "C" - coppia max. di serraggio del dado "C": 2Nm.

Lo spessore massimo della parete di fissaggio deve essere di 3,5mm.

CONNECTORS FOR PANEL MOUNTING WITH PUSH WIRE TERMINALS

Wires connection:

Push-wire connections are suitable for rigid conductors from 0,5 to 2,5 mm² section.

Wires stripping must be 11-12 mm.

Mounting instructions for panel mounting connectors

Insert the connector body "A", with the gasket "AI" already mounted, into the hole "B", taking into consideration the position of the nominal surface which avoids the body to rotate during the screwing of the nut "C" - Max. tightening torque for nut "C": 2Nm.

Maximum suitable fixing wall thickness is 3,5mm.

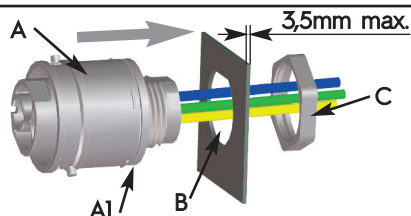

ISTRUZIONI PER IL CORRETTO ACCOPPIAMENTO DEI CONNETTORI

Inserire il connettore con il cavo in quello fissato all'apparecchio "6", rispettando il senso di inserimento.

INSTRUCTIONS FOR CONNECTORS COUPLING

Insert the connector with the cable into the one fixed to the lighting fixture "6", maintaining the insertion position.

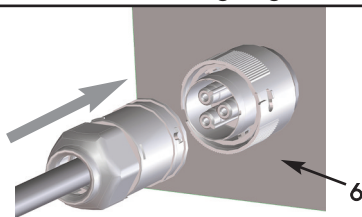

Ruotare completamente la ghiera "7" in modo che i fermi "8" posti sul corpo del connettore entrino perfettamente nelle aperture poste sulla ghiera "7".

Turn completely the sleeve "7" in such a way the locks "8" placed on the connector body come perfectly into the openings placed on the sleeve "7".

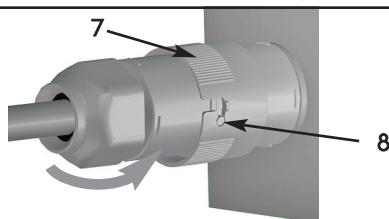

ISTRUZIONI PER IL CORRETTO SGANCIAMENTO DEI CONNETTORI

Ruotare la ghiera "7" ed estrarre il connettore tirandolo per il corpo "3".

ATTENZIONE: Non estrarre il connettore tirando il cavo.

INSTRUCTIONS FOR CONNECTORS UNCOUPLING

Unscrew the sleeve "7" and extract the connector pulling the body "3".

WARNING: Do not pull the cable during the connector extraction.

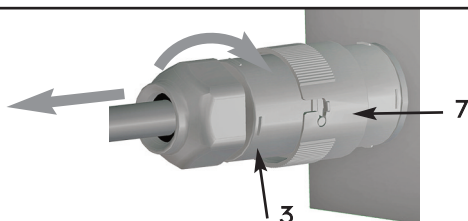

NOTA: L'accoppiamento tra due connettori a vite avviene seguendo la stessa procedura.

NOTE: The coupling between two screw wire terminal connectors is done following the same procedure.