

1016/A

PORTASTARTER STARTERHOLDER

Dati tecnici

Technical data









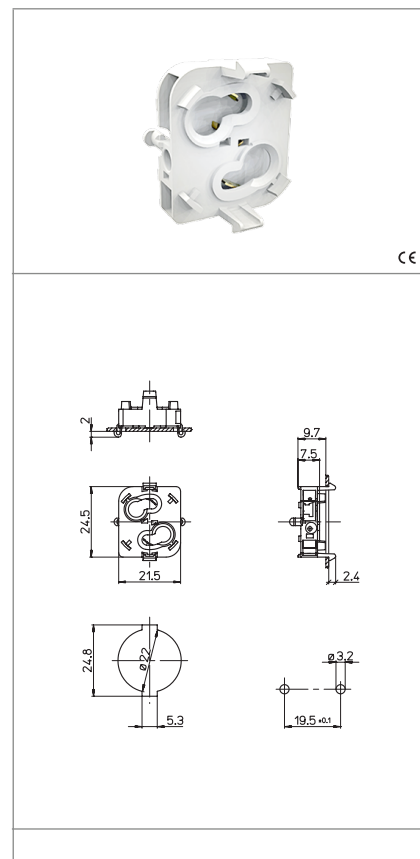

- Corrente e tensione nominale - Rated current and voltage	2A-250V
- Temperatura massima di funzionamento (IEC) - Maximum operating temperature (IEC)	T110
- Grado di protezione - Protection index	IP20
- Categoria di sovratensione - Impulse withstand category	III

Caratteristiche

Characteristics

- Corpo in policarbonato bianco
- White polycarbonate body
- Contatti in lega di rame
- Copper alloy contacts



 fissaggio ad innesto push-in fixing	 spessore lamiera di fissaggio fixing metal plate thickness 0,6-1,2	 fissaggio ad inserimento push-through fixing	 spessore lamiera di fissaggio fixing metal plate thickness 0,6-1
 spessore thickness 7,5	 serrafilo automatico ad 1 foro push-wire terminals with 1 hole	 sezione conduttori rigidi rigid conductor section mm ² 0,5-1	 spelatura cavetti rigidi rigid wires stripping 8-9
 IP40 nei punti d'aggancio IP40 in the hooking points	 S-785/...		

Marchi di qualità

Quality marks

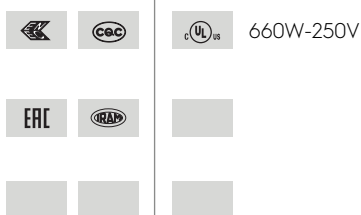

Direttive Europee

European directives

Conforme "RoHS"
"RoHS" compliant
Non soggetto alla "RAEE"
Not subject to "WEEE"

Pesi e confezioni

Weights and packaging

Art. Codice prodotti Product references	g Peso netto Net weight	n° pz per sacco per bag	n° pz per scatola per box	n° pz per cartone per carton
1016/A	2,4	1000		

Note

Notes