

2423/LR-q1-T

2423/LR-q2-T

2423/LR-q3-T

2423/LR-q4-T

2423/LR-q5-T

2423/LR-q6-T

2423/LR-q7-T

**PORTALAMPADE PER LAMPADE FLUORESCENTI COMPATTE (TC-DEL, TC-TEL)
LAMP HOLDERS FOR COMPACT FLUORESCENT LAMPS (TC-DEL, TC-TEL)**

Dati tecnici

Technical data





| | |
|---|-----------------------|
| - Attacco lampada - Lamp Cap | G24q-... GX24q-... |
| - Corrente e tensione nominale - Rated current and voltage | 2A-500V |
| - Temperatura massima di funzionamento (IEC) - Maximum operating temperature (IEC) | T140 |
| - Grado di protezione - Protection index | IP20 |
| - Categoria di sovratensione - Impulse withstand category | III |

Caratteristiche

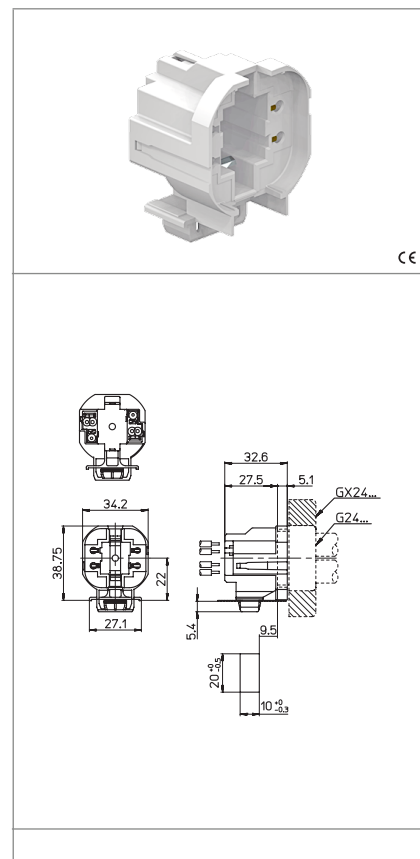
Characteristics

- Corpo in PBT bianco
- White PBT body
- Contatti in lega di rame
- Copper alloy contacts



| | | | |
|--|--|--|---|
|  fissaggio ad innesto snap-in fixing |  spessore lamiera di fissaggio fixing metal plate thickness 0,6-1 |  altezza centro lampada (da sopra la lamiera) lamp centre height (from the top of the metal plate) 22 |  serrafilo automatico a 2 fori push-wire terminals with 2 holes |
|  sezione conduttori rigidi rigid conductor section 0,5-1 |  spelatura cavetti rigidi rigid wires stripping 10-11 |  con fori di guida per i cavetti with wires guidance holes |  isolato in classe II class II insulated |

Marchi di qualità

Quality marks

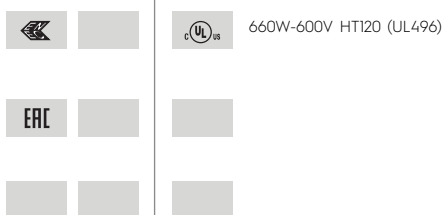

Direttive Europee

European directives

Conforme "RoHS"
"RoHS" compliant
Non soggetto alla "RAEE"
Not subject to "WEEE"

Pesi e confezioni

Weights and packaging

| Art. Codice prodotti Product references | g Peso netto Net weight | n° pz per sacco per bag | n° pz per scatola per box | n° pz per cartone per carton |
|---|-------------------------------|-------------------------------|---------------------------------|------------------------------------|
| 2423/LR-q1-T | | | | |
| 2423/LR-q2-T | 14,3 | 500 | | |
| 2423/LR-q3-T | 14,6 | 500 | | |
| 2423/LR-q4-T | | | | |
| 2423/LR-q5-T | | | | |
| 2423/LR-q6-T | | | | |
| 2423/LR-q7-T | | | | |

Note

Notes