

2423/LD-q1-T

2423/LD-q2-T

2423/LD-q3-T

2423/LD-q4-T

2423/LD-q5-T

2423/LD-q6-T

2423/LD-q7-T

PORTALAMPADE PER LAMPADE FLUORESCENTI COMPATTE (TC-DEL, TC-TEL)
LAMPHOLDERS FOR COMPACT FLUORESCENT LAMPS (TC-DEL, TC-TEL)

Dati tecnici

Technical data





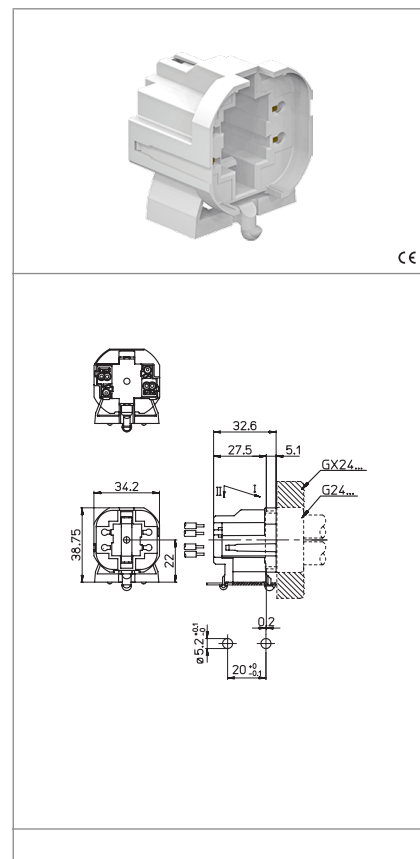

- Attacco lampada - Lamp Cap	G24q-... GX24q-...
- Corrente e tensione nominale - Rated current and voltage	2A-500V
- Temperatura massima di funzionamento (IEC) - Maximum operating temperature (IEC)	T140
- Grado di protezione - Protection index	IP20
- Categoria di sovratensione - Impulse withstand category	III

Caratteristiche

Characteristics

- Corpo in PBT bianco
- White PBT body
- Contatti in lega di rame
- Copper alloy contacts



 fissaggio ad innesto push-in fixing	 spessore lamiera di fissaggio fixing metal plate thickness 0,6-1,2	 altezza centro lampada (da sopra la lamiera) lamp centre height (from the top of the metal plate) 22	 serrafilo automatico a 2 fori push-wire terminals with 2 holes
 sezione conduttori rigidi rigid conductor section 0,5-1	 spelatura cavetti rigidi rigid wires stripping 10-11	 con fori di guida per i cavetti with wires guidance holes	 isolato in classe II class II insulated

Marchi di qualità

Quality marks

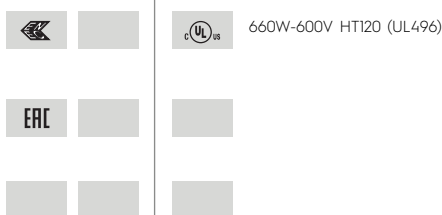

Direttive Europee

European directives

Conforme "RoHS"
"RoHS" compliant
Non soggetto alla "RAEE"
Not subject to "WEEE"

Pesi e confezioni

Weights and packaging

Art. Codice prodotti Product references	g Peso netto Net weight	n° pz per sacco per bag	n° pz per scatola per box	n° pz per cartone per carton
2423/LD-q1-T				
2423/LD-q2-T	13,9	500		
2423/LD-q3-T	13,9	500		
2423/LD-q4-T				
2423/LD-q5-T				
2423/LD-q6-T				
2423/LD-q7-T				

Note

Notes