

3251-H/S-PBT

PORTALAMPADE A COLONNA PER LAMPADE FLUORESCENTI LINEARI T8-T12 ADATTI PER CIRCUITI INSTANT START TOMBSTONE LAMPHOLDER FOR T8-T12 FLUORESCENT LINEAR LAMPS SUITABLE FOR "INSTANT START" CIRCUITS

Dati tecnici

Technical data







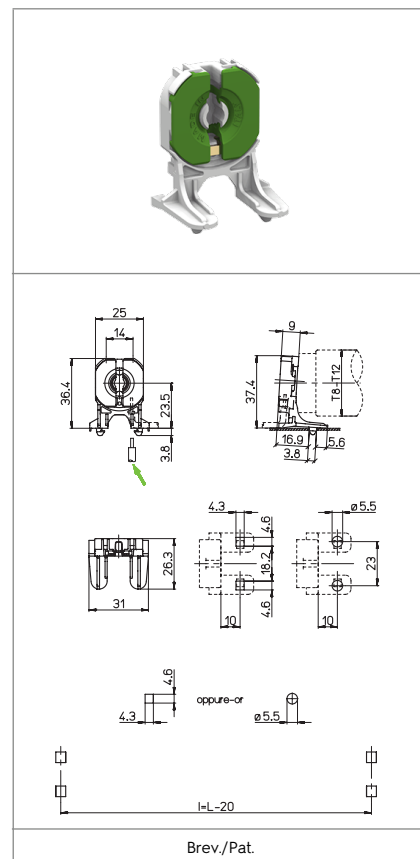

- Attacco lampada - Lamp Cap	G13
- Dati nominali (UL) - Rating (UL)	660W-600V
- Temperatura nominale (UL496) - Temperature rating (UL496)	HT120

Caratteristiche

Characteristics

- Corpo in PBT bianco
- White PBT body
- Contatti in lega di rame cortocircuitati
- Copper alloy shunted contacts
- Con top test
- With top test



 fissaggio ad innesto push-in fixing	 spessore lamiera di fissaggio fixing metal plate thickness 0,6-1	 altezza centro lampada (da sopra la lamiera) lamp centre height (from the top of the metal plate) 23,5	 rotore in PBT con scatti di... PBT rotor with position of... 90°
 serrafilo automatico a 2 fori push-wire terminals with 2 holes	 sezione conduttori solidi, cordati stagnati o preparati solid CU wire or solder dipped stranded or bonded stranded conductors AWG18	 spelatura cavetti wires stripping 8-10	 IP40 nei punti d'aggancio IP40 in the hooking points
 con contatti cortocircuitati internamente (UL496, UL1598) with internally shunted contacts (UL496, UL1598)			

Marchi di qualità

Quality marks



Direttive Europee

European directives

Conforme "RoHS"
"RoHS" compliant
Non soggetto alla "RAEE"
Not subject to "WEEE"

Pesi e confezioni

Weights and packaging

Art. Codice prodotti Product references	g Peso netto Net weight	n° pz per sacco per bag	n° pz per scatola per box	n° pz per cartone per carton
3251-H/S-PBT	5,5	500		

Note

Notes