

3345/FAU-9,5-TR

3345/MAU-9,5-TR

3345-C/FAU-9,5-TR

3345-C/MAU-9,5-TR

PORTALAMPADE A PASTIGLIA PER LAMPADE FLUORESCENTI LINEARI T8-T12
ROUND LAMPHOLDER FOR T8-T12 FLUORESCENT LINEAR LAMPS

Dati tecnici

Technical data









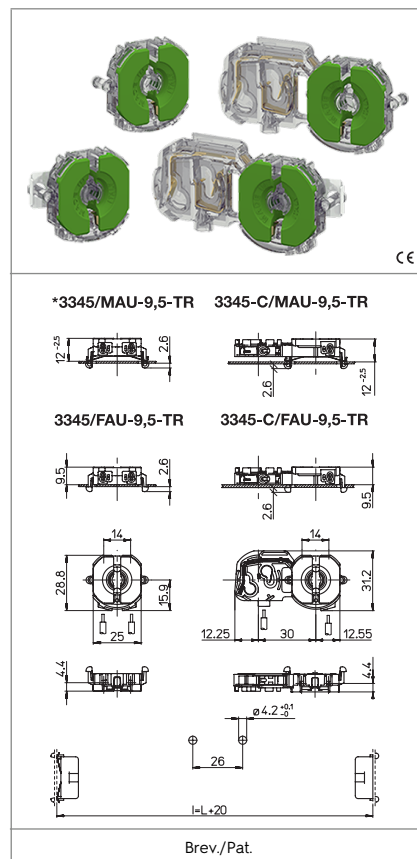

- Attacco lampada - Lamp Cap	G13
- Corrente e tensione nominale - Rated current and voltage	2A-500V; 2A-250V(...-C/...)
- Temperatura massima di funzionamento (IEC) - Maximum operating temperature (IEC)	T140 Tm110
- Grado di protezione - Protection index	IP20
- Categoria di sovratensione - Impulse withstand category	II

Caratteristiche

Characteristics

- Corpo in policarbonato trasparente
- Transparent polycarbonate body
- Contatti in lega di rame
- Copper alloy contacts
- Con top test
- With top test



 fissaggio ad innesto posteriore, fisso back mounting, fixed	 fissaggio ad innesto posteriore, mobile back mounting, adjustable	 spessore lamiera di fissaggio fixing metal plate thickness 0,6-1,2	 spessore thickness 9,5
 rotore in PBT con scatti di... PBT rotor with position of...	 serrafilo automatico a 2 fori push-wire terminals with 2 holes	 sezione conduttori rigidi rigid conductor section 0,5-1	 spelatura cavetti rigidi rigid wires stripping 8-10
 *123	 *124		

Marchi di qualità

Quality marks

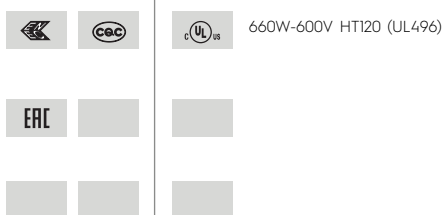

Direttive Europee

European directives

Conforme "RoHS"
"RoHS" compliant
Non soggetto alla "RAEE"
Not subject to "WEEE"

Pesi e confezioni

Weights and packaging

Art. Codice prodotti Product references	g Peso netto Net weight	n° pz per sacco per bag	n° pz per scatola per box	n° pz per cartone per carton
3345/FAU-9,5-TR	4,2	1000		
3345/MAU-9,5-TR	4,8	1000		
3345-C/FAU-9,5-TR	6,8	1000		
3345-C/MAU-9,5-TR	7,6	1000		

Note

Notes