

3345-H/FAU-9,5-PBT

3345-H/MAU-9,5-PBT

PORTALAMPADE A PASTIGLIA PER LAMPADE FLUORESCENTI LINEARI T8-T12 ADATTI PER CIRCUITI INSTANT START ROUND LAMP HOLDERS FOR T8-T12 FLUORESCENT LINEAR LAMPS SUITABLE FOR INSTANT START CIRCUITS

Dati tecnici

Technical data

- Attacco lampada - Lamp Cap	G13
- Dati nominali (UL) - Rating (UL)	660W-600V
- Temperatura nominale (UL496) - Temperature rating (UL496)	HT120

Caratteristiche

Characteristics

- Corpo in PBT bianco
- White PBT body
- Contatti in lega di rame cortocircuitati
- Copper alloy shunted contacts
- Con top test
- With top test

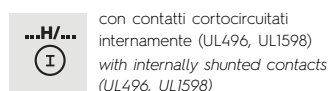
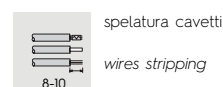
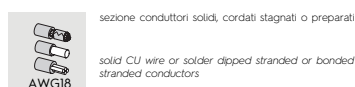
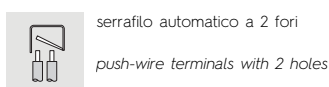
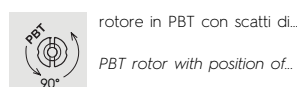
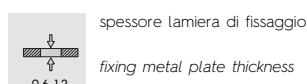
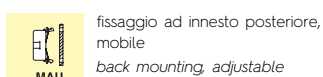
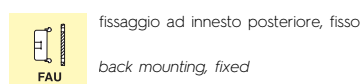
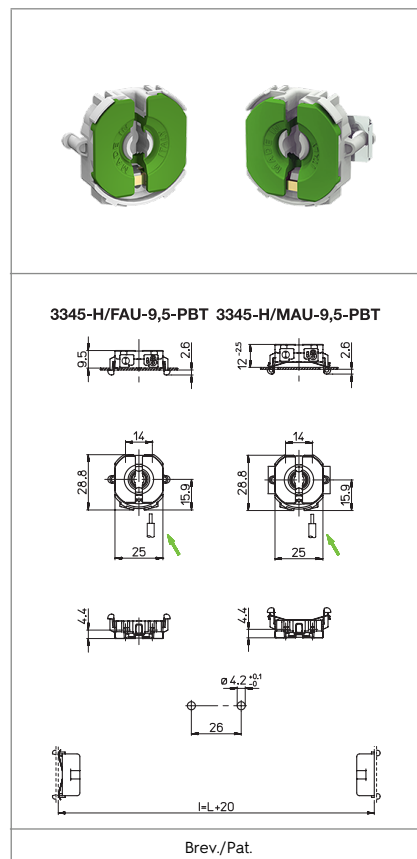

Marchi di qualità

Quality marks

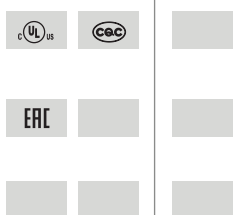

Direttive Europee

European directives

Conforme "RoHS"
"RoHS" compliant
Non soggetto alla "RAEE"
Not subject to "WEEE"

Pesi e confezioni

Weights and packaging

Art. Codice prodotti Product references	g Peso netto Net weight	n° pz per sacco per bag	n° pz per scatola per box	n° pz per cartone per carton
3345-H/FAU-9,5-PBT	4,4	1000		
3345-H/MAU-9,5-PBT	5,1	1000		

Note

Notes