

1282-SLS/FAU-PBT

PORTALAMPADE A PASTIGLIA PER LAMPADE FLUORESCENTI T5 SEAMLESS ROUND LAMPHOLDERS FOR T5 SEAMLESS LAMPS

Dati tecnici

Technical data





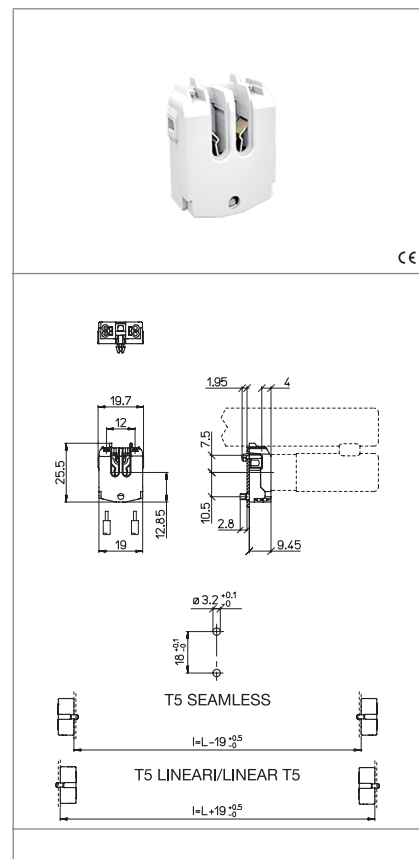

- Attacco lampada - Lamp Cap	G5
- Corrente e tensione nominale - Rated current and voltage	2A-500V
- Temperatura massima di funzionamento (IEC) - Maximum operating temperature (IEC)	T140
- Grado di protezione - Protection index	IP20
- Categoria di sovratensione - Impulse withstand category	II

Caratteristiche

Characteristics

- Corpo in PBT bianco
- White PBT body
- Contatti in lega di rame
- Copper alloy contacts
- Con top test
- With top test



 fissaggio ad innesto posteriore, fisso <i>back mounting, fixed</i>	 spessore lamiera di fissaggio <i>fixing metal plate thickness</i> 0,6-1,2	 spessore <i>thickness</i> 9,45	 serrafilo automatico a 2 fori <i>push-wire terminals with 2 holes</i>
 sezione conduttori rigidi <i>rigid conductor section</i> 0,5-1	 spelatura cavetti rigidi <i>rigid wires stripping</i> 8-9	 S-1282-SLS/3	

Marchi di qualità

Quality marks

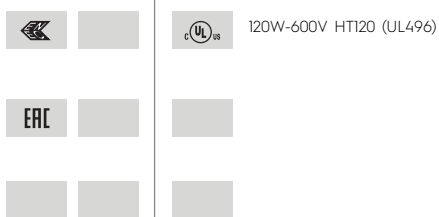

Direttive Europee

European directives

Conforme "RoHS"
"RoHS" compliant
Non soggetto alla "RAEE"
Not subject to "WEEE"

Pesi e confezioni

Weights and packaging

Art. Codice prodotti Product references	g Peso netto Net weight	n° pz per sacco per bag	n° pz per scatola per box	n° pz per cartone per carton
1282-SLS/FAU-PBT	3,4	1000	500	

Note

Notes