

## 283/LR-23-TR

### PORTALAMPADE A COLONNA PER LAMPADIE FLUORESCENTI LINEARI T5 CON PASSAFILO TOMBSTONE LAMPHOLDER FOR T5 FLUORESCENT LINEAR LAMPS WITH WIREHOLDER

#### Dati tecnici

##### Technical data







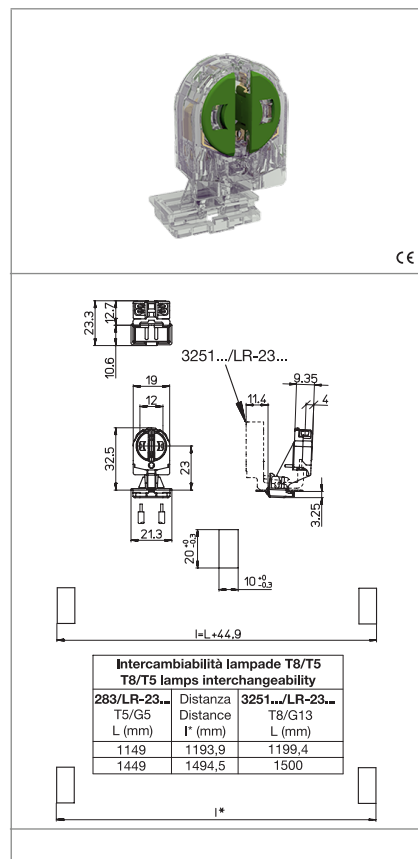

- Attacco lampada - Lamp Cap	G5
- Corrente e tensione nominale - Rated current and voltage	2A-500V
- Temperatura massima di funzionamento (IEC) - Maximum operating temperature (IEC)	T130 Tm110
- Grado di protezione - Protection index	IP20
- Categoria di sovratensione - Impulse withstand category	III

#### Caratteristiche

##### Characteristics

- Corpo in policarbonato trasparente  
- Transparent polycarbonate body
- Contatti in lega di rame  
- Copper alloy contacts
- Con top test  
- With top test



 fissaggio ad innesto snap-in fixing	 spessore lamiera di fissaggio fixing metal plate thickness 0,6-1	 altezza centro lampada (da sopra la lamiera) lamp centre height (from the top of the metal plate) 23	 rotore in PBT verde con scatti di... PBT green rotor with position of... 90°
 serrafilo automatico a 2 fori push-wire terminals with 2 holes	 sezione conduttori rigidi rigid conductor section 0,5-1 mm <sup>2</sup>	 spelatura cavetti rigidi rigid wires stripping 8-9	 IP40 nei punti d'aggancio IP40 in the hooking points
 con passafilo integrato with integrated wireholder			

#### Marchi di qualità

##### Quality marks

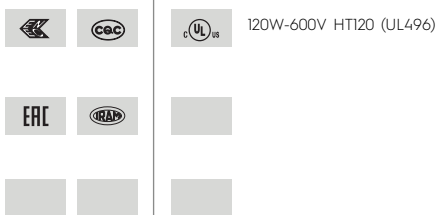

#### Direttive Europee

##### European directives

Conforme "RoHS"  
"RoHS" compliant  
Non soggetto alla "RAEE"  
Not subject to "WEEE"

#### Pesi e confezioni

##### Weights and packaging

Art. Codice prodotti Product references	g Peso netto Net weight	n° pz per sacco per bag	n° pz per scatola per box	n° pz per cartone per carton
283/LR-23-TR	4	1000		

#### Note

##### Notes

## Note

### Note

I portalampade **283/LR-23...** (T5) e **3251.../LR-23...** (T8) permettono di utilizzare, nello stesso apparecchio di illuminazione, sia lampade T5 che T8 senza dover prevedere nessuna modifica nella dimensione e nella distanza delle cave di fissaggio dei portalampade (vedi fig. 1).

L'intercambiabilità delle lampade T5-T8 è possibile solo tra le lunghezze di lampada (e relative potenze) elencate di seguito:

T8: L=1199,4 mm (es.36W)	↔	T5: L=1149 mm (es. 28-54W)
T8: L=1500 mm (es. 58W)	↔	T5: L= 1449 mm (es. 35-80W)

*Lampholders **283/LR-23...** (T5) and **3251.../LR-23...** (T8) allow to use T5 and T8 lamps in the same luminaire, without modifying the dimension and the distance of the lampholder fixing holes (see fig.1).*

*The interchangeability of the T5 and T8 lamps is possible only among the following lamps lengths (and relevant wattages):*

<i>T5: L=1149 mm (i.e. 28-54W)</i>	<i>↔</i>	<i>T8: L=1199,4 mm (i.e. 36W)</i>
<i>T5: L=1449 mm (i.e. 35-80W)</i>	<i>↔</i>	<i>T8: L=1500 mm (i.e. 58W)</i>

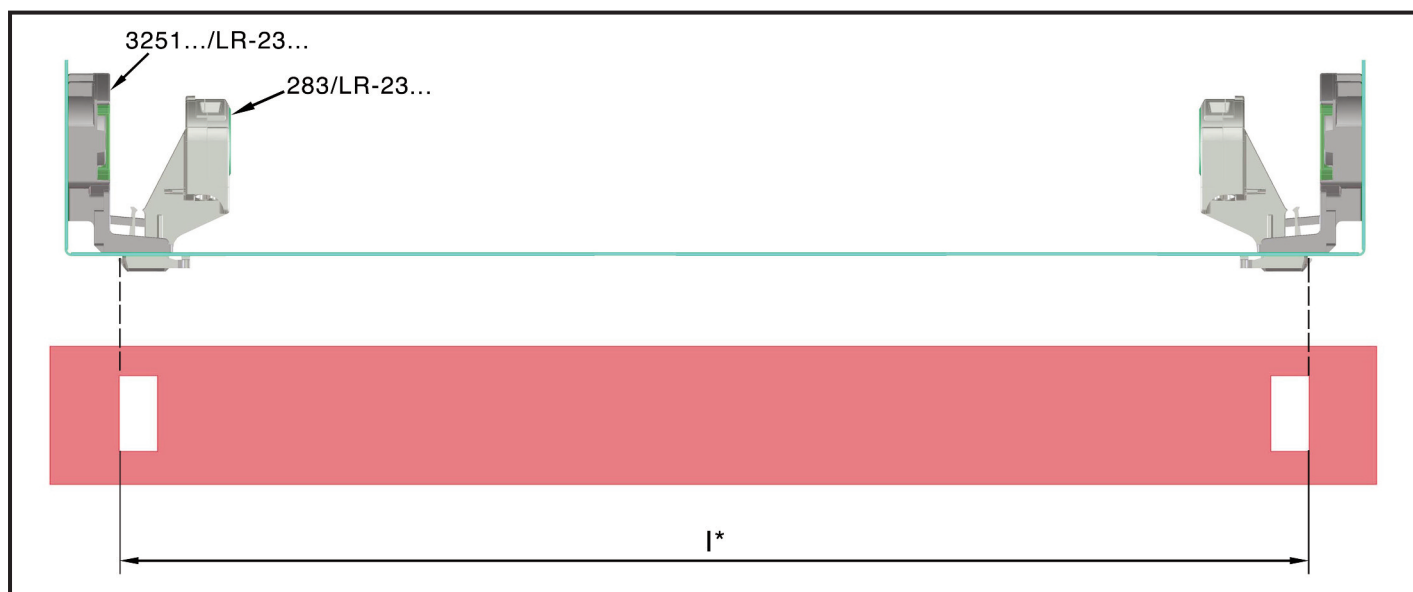

Fig. 1